

SMART WIRELESS ELECTRO-INSTALLATION



ELKO EP, Holding

The company ELKO EP has been one of the leading European players in the field of residential and industrial electrical devices for more than 24 years. Since 2007, the company has been developing and producing its own system of Smart Home & Building Solutions called iNELS.

At present, ELKO EP employs nearly 240 people, exports to 70 countries around the world and already has 13 foreign branches. The company is justly proud to produce its own components, and to have its own development and innovation of new products. It is also able to offer its customers instantaneous distribution and rapid, flawless service. The company became the Company of the Year in 2012 and earned its place as one of the TOP 100 Czech companies.



Facts and Stats



2nd position
in Europe

13
BRANCHES
OVER THE WORLD

70
EXPORTING
COUNTRIES

240
EMPLOYEES

5 000
iNELS INSTALLATION

12 000 000
MANUFACTURED PRODUCTS

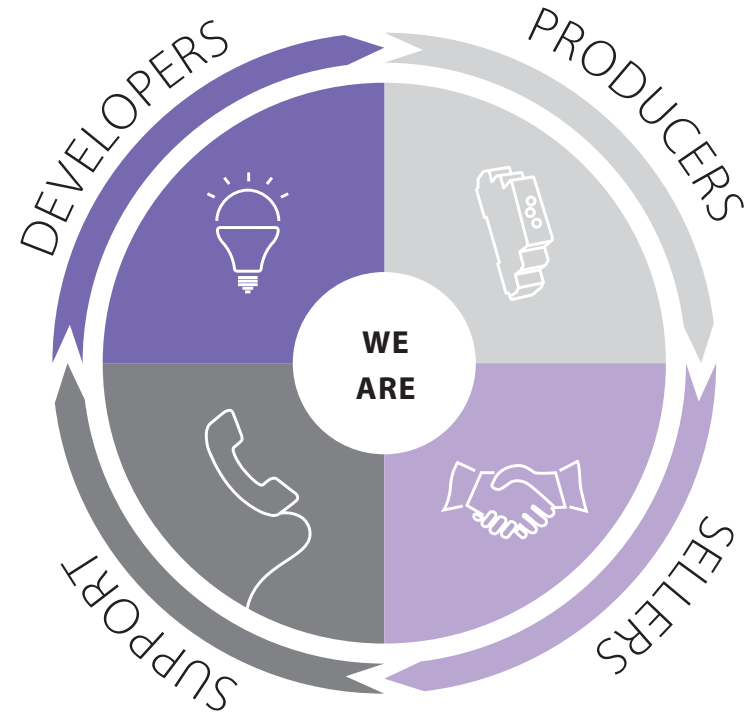



Communication is performed at a frequency of 868 MHz (building automation), bidirectional RF Control Protocol. Range in free space (open area) is 200 m, but it's less (at around 40 to 50 meters), depending on the structural design of the building. Generally, the most disruptive material for communication is steel reinforced concrete, the least disruptive is drywall. In case you have problems with range, you can use the repeater (A signal repeater). In the case that you want to transmit a signal through the ceilings, an effective solution is the eLAN-RF-003 smart box. The installation as such is through a variable RF communication, we always recommend direct visibility or locating the central unit in the middle of the room. Components of DIN rail or wall outlets have clear rules for their installation, however, components in the BOX version can be installed in wiring boxes, covers, lighting fixtures, ceiling ...

Components (let's call them the receiver) as such are divided according to the method of control (dimmer switches, temperature ...) and are powered by a mains voltage of 230 V. Moreover, the thermal components are protected against loss of communications where controlled heating circuit is switched off. They also have built-in protection in the case of power failure and restoration, where it checks the status versus modes programmed in the system unit. The contact is not a contact,

and therefore, the switches of iNELS RF Control have an integrated 16 A AgSnO contact, which also allows the switching of inductive loads.

We have not forgotten dimmers in the management of LED light sources integrating the possibility of setting a minimum brightness to eliminate flicker during dimming. For no reputable manufacturers is often a problem with bilateral solutions and control wiring to the existing switch and simultaneously - wireless method, which we deal with in products RFDEL-71 and RFSA-61B.

Actuator are 50 % battery powered due to the variability of location where they have a life of 3-5 years, battery power guarantees quiet operation through wireless switches and micro switches without problems and a smooth press. Other system components for measuring the temperature are powered by 230 V - as they run with frequent communications and display authentic temperatures.

Installation manual iNELS RF Control for download: <http://www.elkoep.com/download/inels-rf-control/catalogues/>

Communication between components wirelessly at a frequency of 868 MHz, using a completely unique protocol RFIO (the proprietary wireless protocol of ELKO EP), which is unique in its structure. The advantages protocol RFIO:

- Reliably transmits small data packet transfer at a rate up to 100 Kbit / s
- Requires no fees or licenses
- Operating frequency does not conflict with (Wi-Fi / Bluetooth) devices

- No unnecessary communication (flood packets) and no unaddressed commands
- Low energy communication
- Wireless data transmission between system components takes place where other receivers within range help to transfer the information (packet) to the remote receiver, which would be beyond reach separately. Thus, it is possible to cover objects (buildings) of a larger scale and increase transmission reliability within demanding buildings.

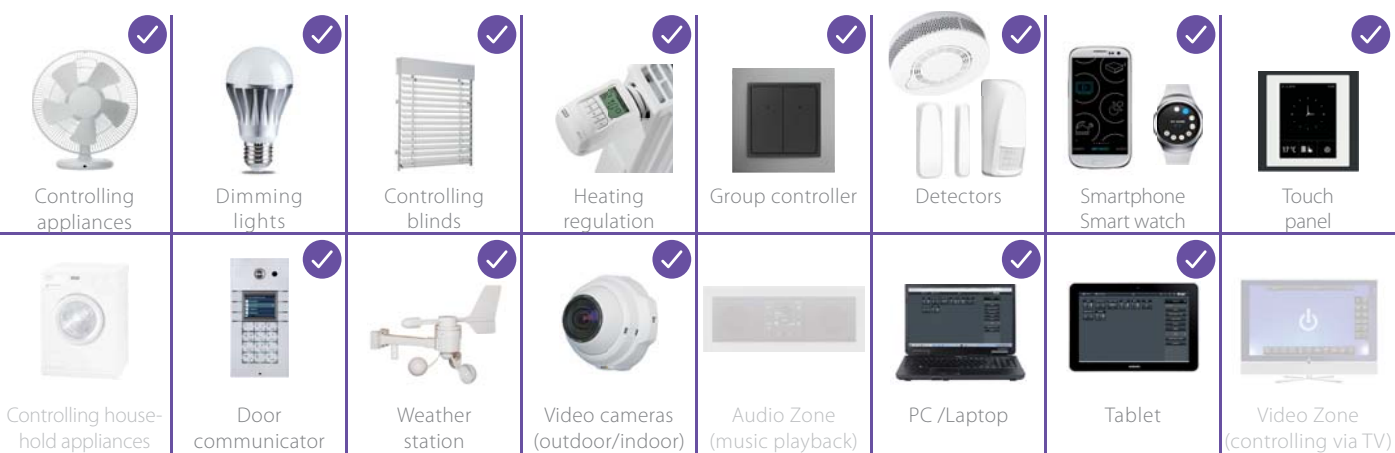

Price of installation:



Energy savings:



ELKO Cloud is a springboard for controlling from a smart phone from outside the network (without rebuilding the router's settings). It is a centre for the control components of iNELS RF Control; it contains the backup settings and gives you information about the energy consumed.

See here: www.elkoep.cloud

The screenshot shows the ELKO Cloud web interface. At the top, there is a login section with fields for Username and Password, and a 'Sign In' button. Below this is the 'SYSTEM MANAGEMENT' dashboard, which includes a navigation menu with icons for Home, Rooms, Scenes, Camera, Alarm, Intercom, Weather, and Energy. The main content area shows a 'Kitchen' section with a 'Temperature' slider set to 15% and an 'RGB Lamp / Kitchen' section with a color picker. A 'Temperature / Hall' section shows a current temperature of 24°C and a list of other rooms with their temperatures: 18°C, 20°C, 22°C, and 26°C. Below the dashboard is the 'ENERGY METERING' section, which displays energy consumption for water and gas, and a table for electricity consumption across different phases and times of day. The table is as follows:

Měřený bod	Spotřeba		Útrata	
	dnes	včera	dnes	včera
Fáze 1	4,9 kWh	2,1 kWh	11,28 Kč	4,82 Kč
Fáze 2	1,5 kWh	2,7 kWh	3,55 Kč	6,12 Kč
Fáze 3	11,7 kWh	29,9 kWh	27,01 Kč	69,03 Kč
Celkový odběr	18,1 kWh	34,6 kWh	41,85 Kč	79,97 Kč

Annotations on the screenshot include: 'Login' pointing to the login fields; 'Control menu' pointing to the navigation icons; 'Control component' pointing to the temperature and lamp controls; 'Energy consumption - water' and 'Energy consumption - gas' pointing to the energy metering cards; 'Energy consumption - electricity (up to 4 tariffs)' pointing to the electricity consumption table; 'History of measurement' pointing to the 'ENERGY METERING' section; and 'Measurement chart' pointing to the donut chart in the electricity consumption section.

Wireless control system

Overview of wireless system units	8
iNELS Wireless System	11
Controllers	
RFWB-20/G, RFWB-40/G Wireless wall controller	12
RF KEY 4 button controller - keychain	13
RF Pilot Wireless remote controller with display	14
RFIM-20B, RFIM-40B Wireless contact converter	16
RFSG-1M Wireless contact converter	17
System units	
RF Touch Wireless touch unit	18
eLAN-RF-003, eLAN-RF-Wi-003 Smart RF box	20
Control apps	21
RFSGM-220M Multifunctional GSM communicator	22
RFRP-20 Repeater to extend the range	24
Switches	
RFSA-11B, RFSA-61B Wireless switch unit	25
RFSA-62B Wireless switch unit	26
RFSAI-61B Wireless switch unit with the input	27
RFSA-61M, RFSA-66M Wireless switch unit	28
RFSC-61 Switching socket	29
RFUS-61 Switch unit for outdoor use	30
RFJA-12B Switch unit for shutters	31
Dimmers	
RFDA-73M/RGB Dimming actuator	32
RFDEL-71B Universal dimmer	34
RFDEL-71M Universal dimmer	35
RFDW-71 Wireless dimmer switch	36
RFDC-71 Dimming socket	37
RFDAC-71B Analog controller	38
Lighting	
RF-RGB-LED-550, RF-White-LED-675 Wireless bulb	39
RF-SOU-1 Wireless twilight switch	40
Temperature control	
RFATV-1 Wireless thermo-valve	41
RFTI-10B Wireless temperature sensor	42
RFSTI-11B Switch unit with a temperature sensor	43
RFSTI-11/G Switch unit with a temperature sensor	44
RFTC-10/G Simple wireless temperature controller	45
RFTC-50/G Wireless temperature controller	46
RFTC-100/G Wireless temperature controller	47

Monitoring units

RFSF-1B Wireless flood detector	48
---	----

Energy management

RFTM-1 Wireless pulse converter	49
RFPM-2M Energy gateway	50

Detectors

RFSD-100, RFSD-101 Smoke detector	52
RFWD-100 Window / Door detector	52
RFMD-100 Motion detector	53

iNELS Cam IP camera	53
-----------------------------	----

Hotel Room Energy Saving Kit

RFSAI-161B Automatic light control functionality	56
RFSTI-111B Overheating protection of room	58
RFTC-150/G Temperature control	59

Accessories

TELVA 230 V, TELVA 24 V Termodrive	61
AN-I, AN-E Antenna	61
FP-1 Flood probe	61
TC, TZ, Pt100 Thermo sensors	62
CT50 Current transformer	63
LS, MS, WS, IRS Sensors	63

Switches	64
----------------	----

Dimmers	65
---------------	----

Installation possibilities	66
----------------------------------	----

Product dimension	67
-------------------------	----

Protocol and compatibility	68
----------------------------------	----

RF sets	69
---------------	----

Sets	70
------------	----

Controllers



RFWB-20/G
Wireless wall controller
- 2 button



RFWB-40/G
Wireless wall controller
- 4 button



RF Key
4 button controller
- keychain



RF Pilot
Wireless remote
controller with display



RFSG-1M
Wireless contact
converter - 2 inputs



**RFIM-20B,
RFIM-40B**
Wireless contact converter
(2 inputs / 4 inputs)

Switches



RFSA-11B
Wireless switch unit
(single-function)
- 1 output



RFSA-61B
Wireless switch unit
(multi-function)
- 1 output



RFSA-62B
Wireless switch unit
(flush mounted)
- 2 outputs



RFSAI-61B
Wireless switch unit
with the input
(for a pushbutton)



RFS-61M
Wireless switch unit
- 1 output



RFS-66M
Wireless switch unit
- 6 outputs

Dimmers



RFDA-73M/RGB
Dimming actuator



RFDEL-71B
Universal dimmer
(flush mounted)



RFDEL-71M
Universal dimmer
(DIN rail mounted)

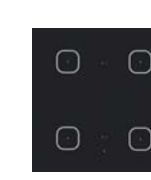

RFDW-71
Wireless Dimmer
Switch



RFDSC-71
Dimming socket
(multi-function)



RFDAC-71B
Analog controller
0(1)-10V

Temperature control



RFATV-1
Wireless thermo-valve



RFSTI-11B
Switch unit with a
temperature sensor
(flush mounted)



RFSTI-11/G
Switch unit with a
temperature sensor



RFTI-10B
Wireless
temperature sensor



RFTC-10/G
Simple wireless
temperature controller



RFTC-50/G
Wireless temperature
controllers

System units



RF Touch-B
Wireless touch unit
- flush mounted



RF Touch-W
Wireless touch unit
- surface mounted



eLAN-RF-003
Smart RF box



eLAN-RF-Wi-003
Smart RF box with
Wi-Fi



RFRP-20
Repeater to extend
the range



RFGSM-220M
Energy gateway



RFSC-61
Switching socket
(multi-function)



RFUS-61
Switch unit for outdoor
use (multi-function)



RFJA-12B/230V
Switch unit for
shutters



RFJA-12B/24V DC
Switch unit for shutters

Lighting



RFSOU-1
Wireless twilight switch



RF-RGB-LED-550
Wireless coloured bulb



RF-White-LED-675
Wireless white bulb

Cameras



iNELS Cam
IP camera



Supported video cameras

Energy management



RFPM-2M
Energy gateway



RFTM-1
Wireless pulse
converter



RFSF-1B
Wireless flood detector



**RFSD-100,
RFSD-101**
Smoke detector
wireless



RFMD-100
Motion detector
wireless



RFWD-100
Window / Door detector
wireless

Accessories



FP-1
Flood probe



TC TZ Pt100
Temperature
sensors



AN-I
Internal
antenna



AN-E
External
antenna



Telva
Thermdrive



CT50
Current transformer



LS, MS, WS, IRS
LED sensor
Magnetic sensor
Infra Red sensor

iNELS Wireless System

RF - radiofrequency protocol
 Wi-Fi



Outdoor PTZ camera



Wi-Fi

Weather station



Indoor PTZ camera



Indoor camera



Controllers:

Application for the smart phone



Wi-Fi Router



Smart IR Box

Detectors:

Smoke



Door / Window

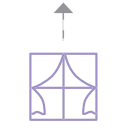

Motion



Smart RF Box Wi-Fi

Sensors:

Flood



Temperature

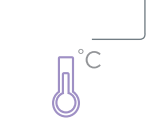

Twilight



Elements:

Switch unit - 6 outputs

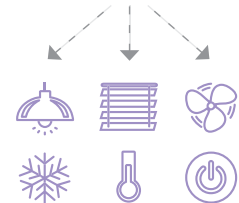

Switch unit - 1 output

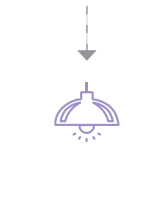

Switching socket



Switch unit for shutters

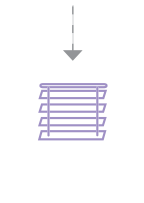

Thermostat for radiator

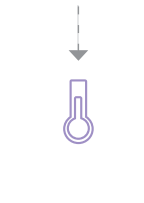

Switch unit - 1 output

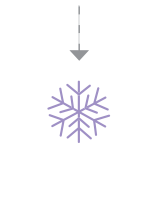

RGB Coloured LED bulb



Dimmer for LED strips

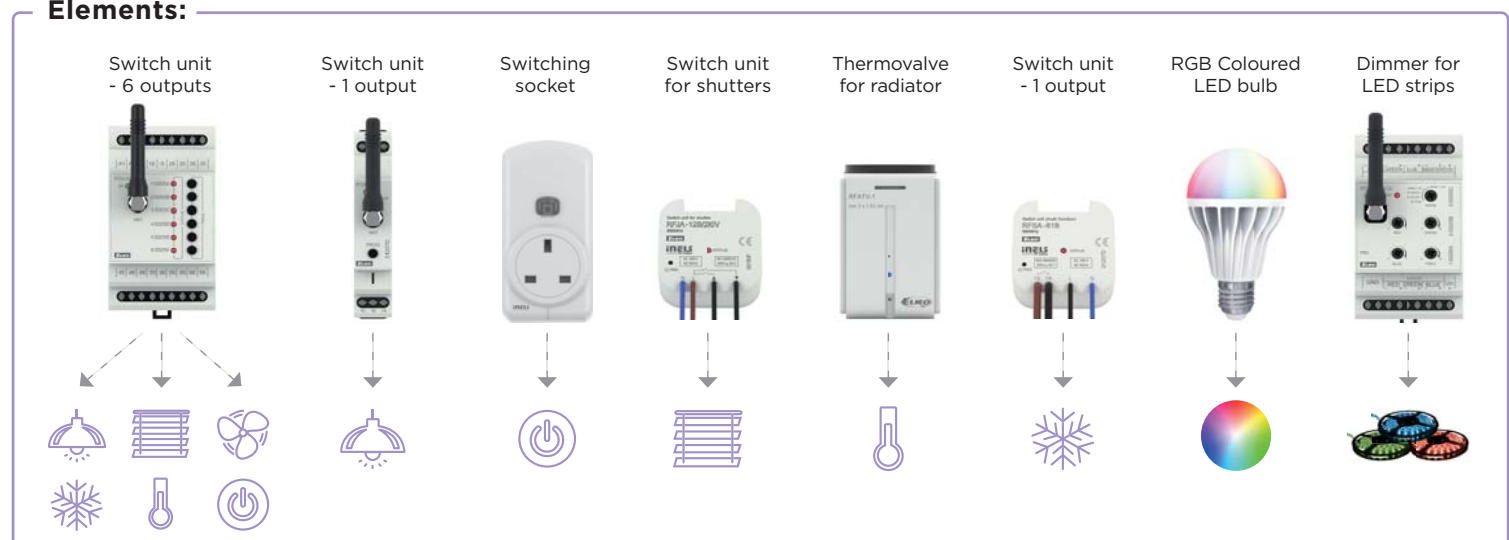
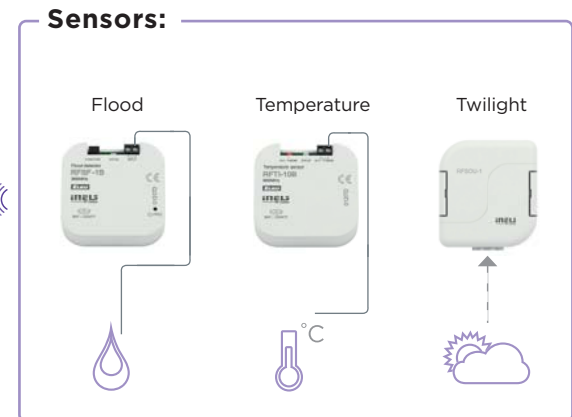
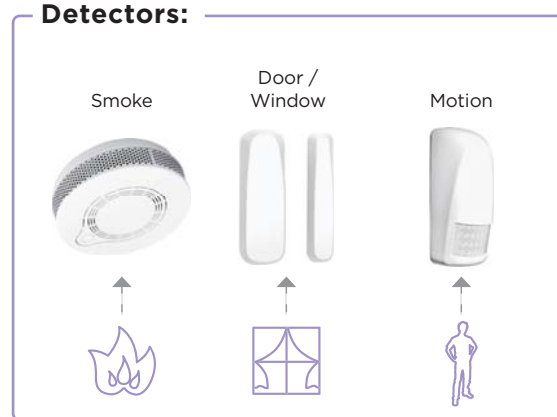
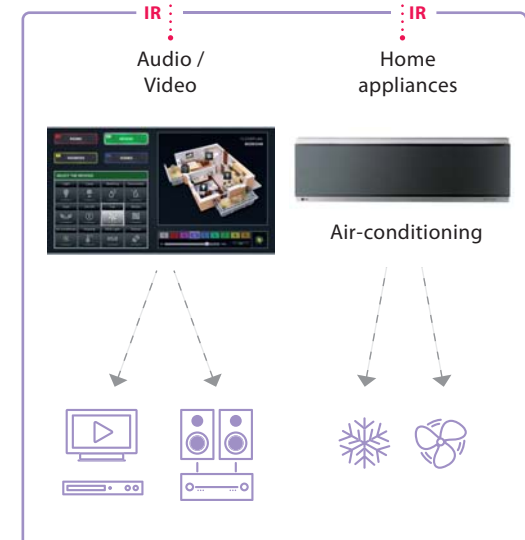
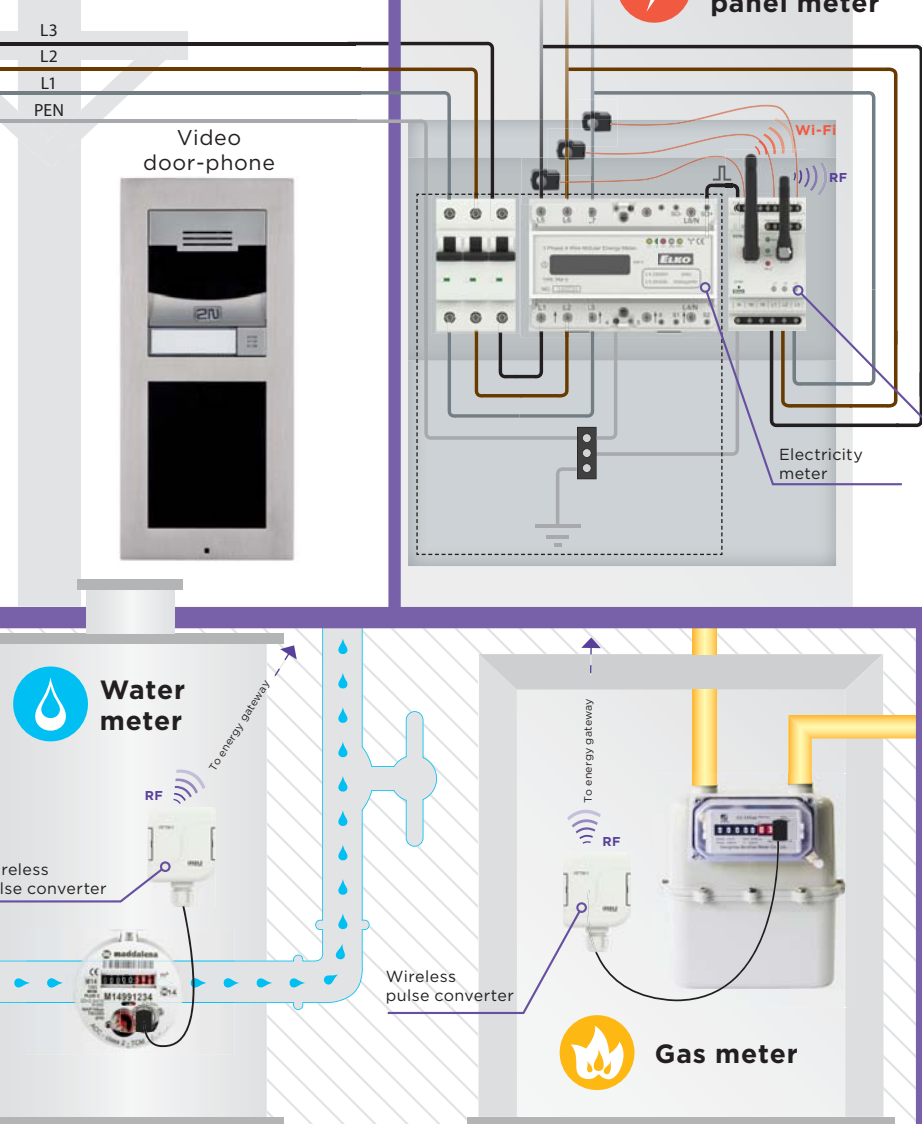
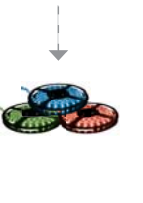

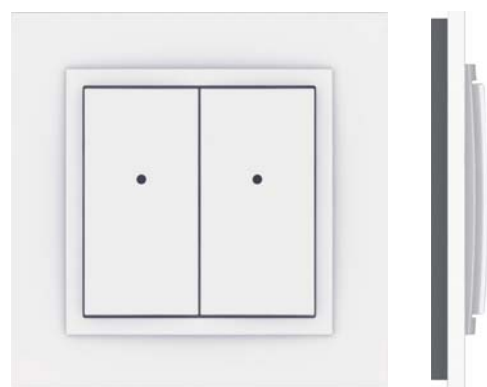

- The wireless controller is used to control switches and dimmers (lights, gate, garage door, blinds, etc.).
- **RFWB-20/G:** two buttons enable control of two units independently.
- **RFWB-40/G:** four buttons enable control of four units independently.
- The flat design with level base makes it ideal for fast installation on any surface (fixation with adhesive or screws in the installation box).
- When pressing the button, it sends a set signal (ON/OFF, dimming, time switching OFF / ON, blinds up/down).
- Sending a command is indicated by a red LED.
- In LOGUS⁹⁰ switch frame design (plastic, glass, wood, metal, stone).
- Option of setting light scenes, where with a single press, you can control units of iNELS RF Control.
- Battery power supply (3 V / CR2032 - included in the supply) with battery life of around 5 years based on frequency of use.
- Range up to 200 m (in open space), if the signal is insufficient between the controller and unit, use the signal repeater RFRP-20.
- Communication frequency with bidirectional protocol iNELS RF Control.

Device description

RFWB-20/G

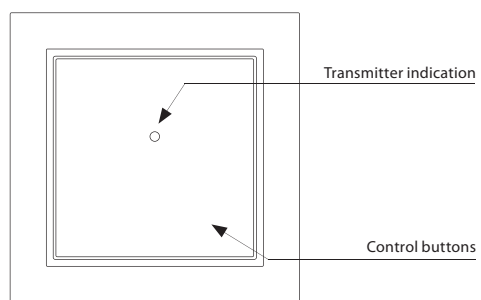

RFWB-40/G

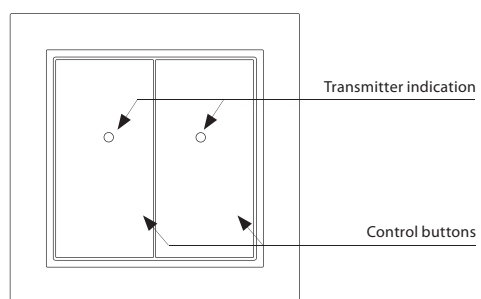

Technical parameters	RFWB-20/G	RFWB-40/G
Supply voltage:	3 V CR 2032 battery	
Transmission indication:	red LED	
Number of buttons:	2	4
Transmitter frequency:	866 MHz, 868 MHz, 916 MHz	
Signal transmission method:	unidirectionally addressed message	
Range in free space:	up to 200 m	
Other data		
Operating temperature:	-10 to +50 °C	
Operating position:	any	
Mounting:	glue / screws	
Protection:	IP 20	
Contamination degree:	2	
LOGUS ⁹⁰ - Dimensions:		
Frame - plastic:	85 x 85 x 16 mm	
Frame - metal, glass, wood, granite:	94 x 94 x 16 mm	
Weight*:	38 g	39 g
Related standards:	EN 60669, EN 300 220, EN 301 489 R&TTE Directive, Order. No 426/2000 Coll. (Directive 1999/EC)	

*Comes with plastic frame. No installation into multi-frames.

Examples of placement



LOGUS⁹⁰

Choose your own style

Flat wireless switches that can be mounted on glass, tile, furniture ... Such a quick change of location when you're moving.

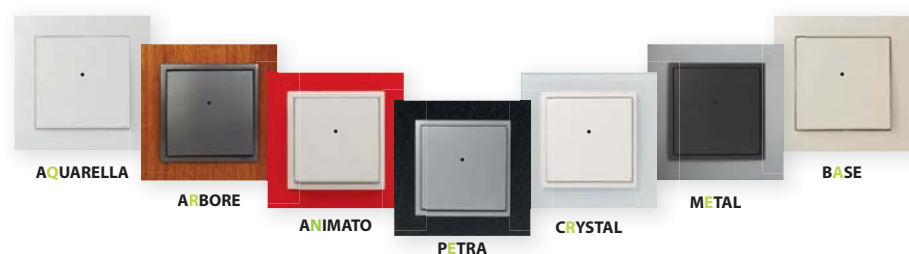

Technical parameters	RF KEY/W	RF KEY/B
Supply voltage:	3 V CR 2032 battery	
Transmission indication:	red LED	
Number of buttons:	4	
Transmitter frequency:	866 MHz, 868 MHz, 916 MHz	
Signal transmission method:	unidirectionally addressed message	
Range in free space:	up to 200 m	
Other data		
Operating temperature:	-10 to +50 °C	
Operating position:	any	
Color design:	white	black
Protection:	IP 20	
Contamination degree:	2	
Dimensions:	64 x 25 x 10 mm	
Weight:	16 g	
Related standards:	EN 60669, EN 300 220, EN 301 489 R&TTE Directive, Order. No 426/2000 Coll. (Directive 1999/EC)	

- The key alarm is used to control switches and dimmers (lights, gate, garage door, blinds, etc.).
- When pressing the button, it sends a set signal (ON/OFF, dimming, time switching OFF / ON, blinds up/down).
- Sending a command is indicated by a red LED.
- Designed in black and white with laser printing.
- Four buttons enable control of four units independently.
- Option of setting light scenes, where with a single press, you can control units of iNELS RF Control.
- Battery power supply (3 V / CR2032 - included in the supply) with battery life of around 5 years based on frequency of use.
- Range up to 200 m (in open space), if the signal is insufficient between the controller and unit, use the signal repeater RFRP-20.
- Communication frequency with bidirectional protocol iNELS RF Control.

Device description

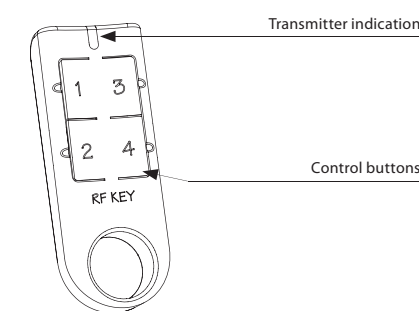



Combine the RF Pilot remote controller with the RF Touch control unit for maximum utilization of the RF Control system features.

Technical parameters	RF Pilot/W	RF Pilot/A
Display		
Type:	color OLED	
Resolution:	128 x 128 pixels	
Side ratio:	1:1	
Visible surface:	26 x 26 mm	
Backlighting:	self-illuminating text	
Diagonal:	1.5"	
Control:	direction button, control buttons	
Power supply		
Power supply:	2 x 1.5 V AAA batteries / R03	
Battery life:	approx. 3 years, according to the frequency of use and battery type	
Control		
Range in free space:	up to 200 m	
Frequency:	866 MHz, 868 MHz, 916 MHz	
Other data		
Operating temperature:	0 to +55 °C	
Storage temperature:	-20 to +70 °C	
Color design:	white	anthracite
Protection:	IP20	
Operating position:	any	
Dimensions:	130 x 41 x 18 mm	
Weight:	61 g	
Related standards:	EN 60730-1	

RF Pilot

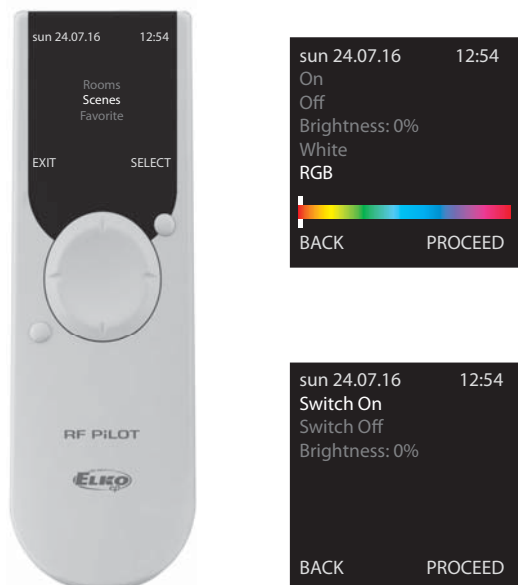

- The RF Pilot remote control is a central controller for switching electrical appliances and equipment, dimming lights, controlling blinds, etc.
- When pressing the button, it sends a set signal (ON / OFF, dimming, time switching OFF / ON, blinds up / down).
- Option of setting light scenes, where with a single press, you can control up to 10 units at once.
- The Favorites mode lets you preset the most frequently used devices on the home screen.
- Option of grouping dimmers (RFDA-73M/RGB), where you can place up to 10 units under a single control panel = control of over 100 m of colored LED strip.
- Designed in white and anthracite with color OLED display.
- Display of room temperature, battery status, date and time directly on display.
- Bidirectional communication, transmits and receives commands and displays the status of units.
- Thanks to the function of measuring the signal between the controller and unit, you can use it for testing the range and signal quality.
- It is possible to combine up to 40 units of iNELS RF Control (you can gradually expand the installation from 1 unit).
- Battery power (1.5 V 2x AAA - included in supply) with battery life of around 3 years based on frequency of use and type of batteries.
- Range up to 200 m (in open space), if the signal is insufficient between the controller and unit, use the signal repeater RFRP-20.
- Communication frequency with bidirectional protocol iNELS RF Control.

Device description

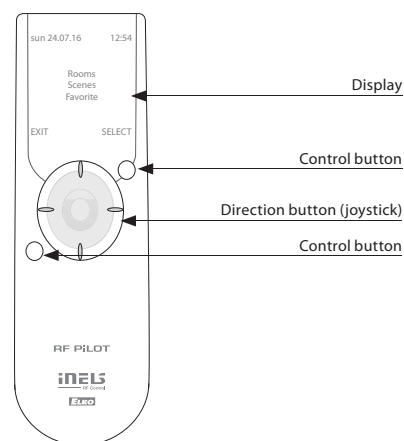

Display description

Color OLED display

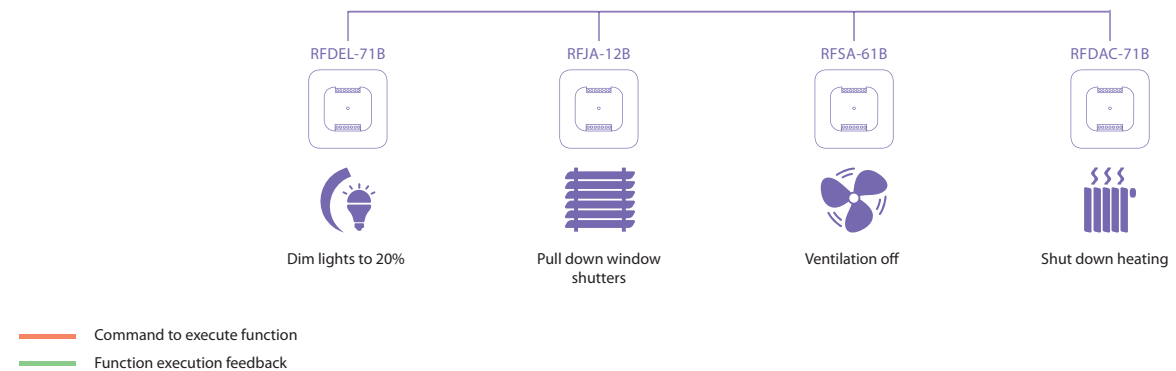
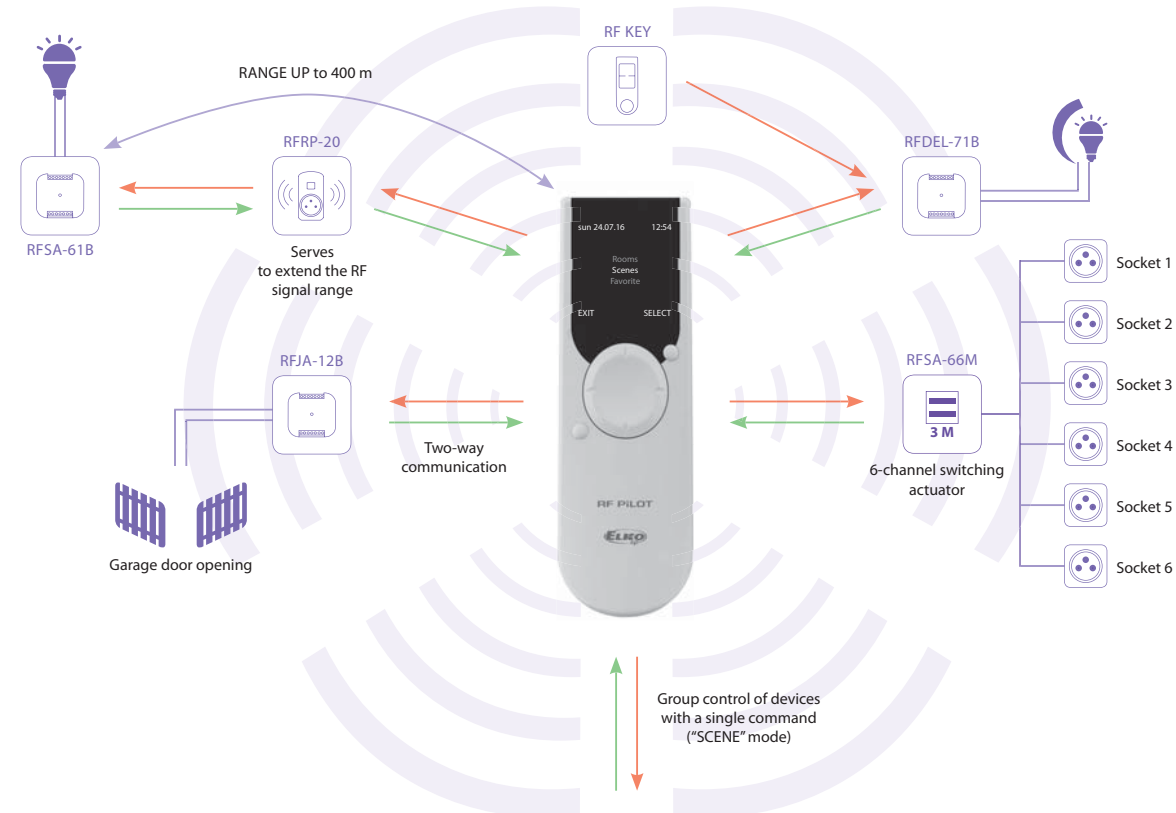
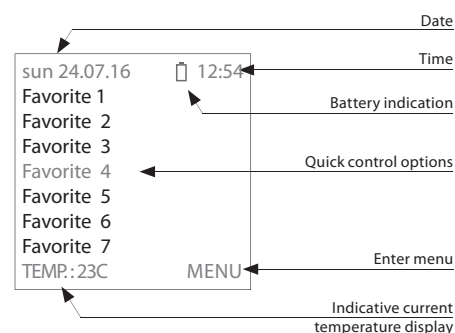

SCENES

- serves to control actuators as a group with a single touch
- possibility to set up scenes; on activation, for example, window shutters are pulled down and the light will adjust to the required brightness

WINDOW SHUTTERS

- controlling window shutters, blinds, garage door, etc.
- window shutters are controlled separately or as a group
- the window shutter receivers are powered by either 230 V or 24 V DC (shutters between windows)

FAVOURITE

- serves to select the most frequently used devices
- on display activation, the "Favourite" menu pops up automatically to provide you with a quick access to controlling devices

SWITCHING

- this function serves to switch on/off lights, sockets, electrical appliances and devices
- intuitive control thanks to customized name options
- switching actuator function selections: switch on/off, impulse relay, button, delayed ON/OFF (time of delay from 2 seconds to 60 minutes)

DIMMING

- the regulation of light intensity (light bulbs, LED strips, halogen lights with electrical or coil transformer, fluorescent tubes with dimmable ballast 1-10 V)
- customizable names of individual dimmed circuits (such as "lights" or "living room")
- "sunrise/sunset" imitation - light gradually goes on or off during the preset period between 2 seconds and 30 minutes

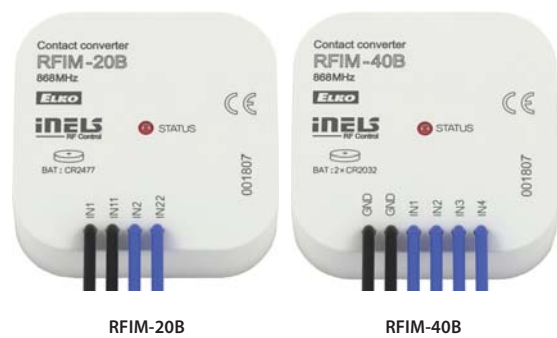

Technical parameters	RFIM-20B	RFIM-40B
Supply voltage:	1x 3 V battery CR 2477	2x 3 V battery CR 2032
Battery life:	5 years	
Transmission indication / function:	orange LED	red LED
Number of inputs:	2	4
Transmitter frequency:	866 MHz, 868 MHz, 916 MHz	
Signal transmission method:	unidirectionally addressed message	
Range in free space:	up to 200 m	

Other data	
Operating temperature:	-10 to +50 °C
Operating position:	any
Terminals (CY wire, cross-section):	4 x 0.75 mm ² 6 x 0.75 mm ²
Length of terminals:	90 mm
Resist. of connection between terminals	
- for switched on button:	< 300 Ω
- for disconnected contact:	> 10 kΩ
Mounting:	free at lead-in wires
Protection:	IP30
Contamination degree:	2
Dimensions:	49 x 49 x 13 mm
Weight:	45 g 50 g
Open contact voltage:	pulse 12 V 3 V
Length of cable to contact:	max. 100 m of parallel lines max. 5 m
Related standards:	EN 60669, EN 300 220, EN 301 489 R&TTE Directive, Order. No 426/2000 Coll. (Directive 1999/EC)

- **RFIM-20B:** the wireless contact converter changes your existing button / switch to a wireless one.
 - two inputs enable control of two units independent.
 - battery power supply (3 V / CR2477 - included in the supply) with battery life of around 5 years based on frequency of use.
- **RFIM-40B:** the wireless contact converter changes your existing button to a wireless one.
 - four inputs enable control of four units independently.
 - battery power supply (2x 3 V / CR2032) with battery life of around 5 years based on frequency of use (included in the supply).
- It can be used to transmit information on switching on the contact (detector, button, technology, logic output).
- The BOX design lets you mount it right in an installation box under the button or switch.
- When pressing the button, it sends a set signal (ON/OFF, dimming, time switching OFF / ON, blinds up/down).
- Sending a command is indicated by a red LED.
- Option of setting light scenes, where with a single press, you can control multiple units of iNELS RF Control.
- Range up to 200 m (in open space), if the signal is insufficient between the controller and unit, use the signal repeater RFRP-20.
- Communication frequency with bidirectional protocol iNELS RF Control.

Device description

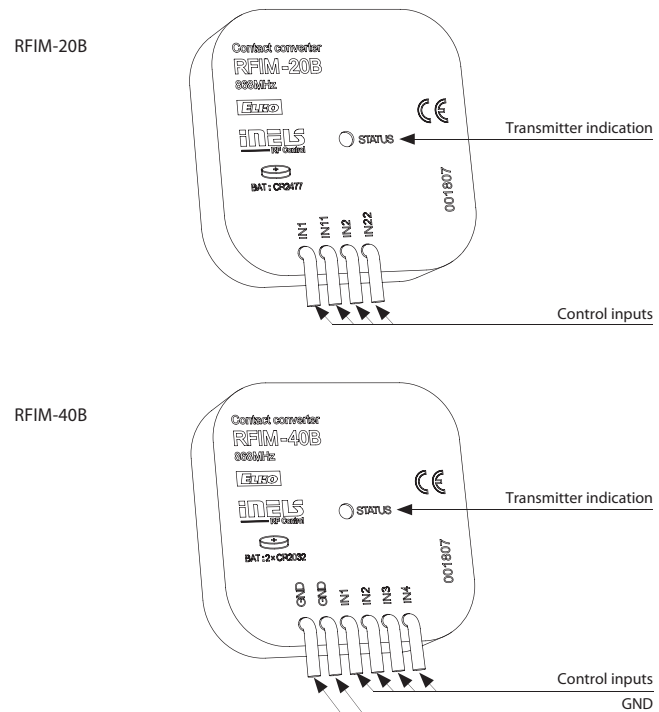

Connection

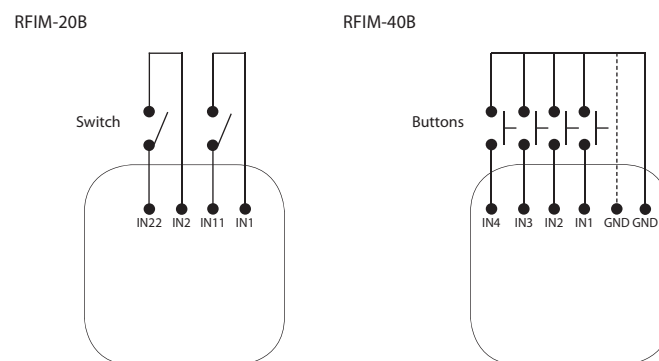

Technical parameters	RFSG-1M/230V	RFSG-1M/24V
Supply voltage:	110-230 V AC / 50-60 Hz	12-24 V AC/DC / 50-60 Hz
Apparent input:	2 VA	-
Dissipated power:	0.2 W	0.5 W
Supply voltage tolerance:	+10 % / -25 %	
Power supply indication:	green LED	

Input	
Control voltage:	AC 12-230 V / DC 12-230 V
Control input power:	AC 0.025 VA / DC 0.1 W
Control terminals:	S - S
The length of control impulse:	min. 25ms (max. unlimited)
Transmission indication / function:	red LED
Transmitter frequency:	866 MHz, 868 MHz, 916 MHz
Signal transmission method:	unidirectionally addressed message
Range in free space:	up to 160 m
Minimum control distance:	20 mm
Output for antenna:	SMA connector*

Other data	
Operating temperature:	-15 to +50 °C
Operating position:	any
Mounting:	DIN rail support EN 60715
Protection:	IP20 from the front panel
Overvoltage category:	III.
Contamination degree:	2
Connecting conductor cross-section: (mm ²):	max. 1x 2.5, max. 2x 1.5 / with a hollow max. 1x 2.5
Dimensions:	90 x 17.6 x 64 mm
Weight:	62 g
Related standards:	EN 60669, EN 300 220, EN 301 489 R&TTE Directive, Order. No 426/2000 Coll. (Directive 1999/EC)

* Max Tightening Torque for antenna connector is 0.56 Nm.

- This wireless contact converter is especially appropriate for wireless transmission of information on switching HDO.
- Thanks to the network supply, it can also be used for partial transmission of information for control of an appliance or device.
- One-module design of the unit with mounting into switchboard.
- After leading in power to the "S" terminals, it periodically transmits the command switch on in an interval of 10 min. When disconnecting the power supply, immediately switch off.
- The button TEST on the controller is used to assign to a switching unit.
- Option of setting light scenes, where with a single press, you can control multiple units of iNELS RF Control.
- The package includes an internal antenna AN-I, in case of locating the converter in a metal switchboard, you can use the external antenna AN-E for better signal reception.
- Range up to 160 m (in open space), if the signal is insufficient between the controller and unit, use the signal repeater RFRP-20.
- Communication frequency with bidirectional protocol iNELS RF Control.

Device description

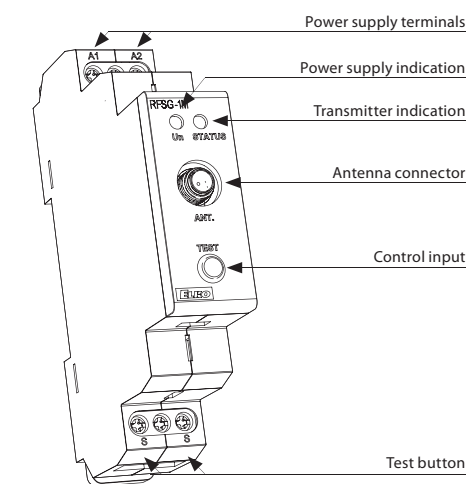

Connection





Technical parameters		RF Touch-B	RF Touch-W
Display			
Type:		color TFT LCD	
Resolution:		320 x 240 pixels / 262,144 colors	
Side proportion :		3:4	
Visible surface:		52.5 x 70 mm	
Backlighting:		active (white LED)	
Touch area:		resistive 4-conductor	
Diagonal:		3.5"	
Control:		touch	
Power supply			
Supply voltage/rated current:		100 -230 V AC	from the back 100 – 230 V AC, from the side 12 V DC*
Input power:		max. 5W	
Power supply terminals:		A1 - A2	
Control			
Range:		100 m	
Min. distance RF Touch - Actuator:		1m	
Frequency:		866 MHz, 868 MHz, 916 MHz	
Connection			
Connection:		terminal box	no-screw push-in terminal box or jack Ø 2.1 mm jack connector
Cross-section of connecting wires:		max. 2.5 mm ² /1.5 mm ² with a hollow	
Operating conditions			
Operating temperature:		0 to +50°C	
Storage temperature:		- 20 to +70°C	
Protection:		IP 20	
Overvoltage category:		III.	
Contamination degree:		2	
Operating position:		any	
Installation:		an installation box	anywhere indoor
Dimensions:		94 x 94 x 36 mm	94 x 94 x 24 mm
Weight:**		127 g	175 g
Related standards:		EN 60730-1	

* Adapter is included in the RF Touch-W unit package.
** Weight includes the plastic frame and the intermediate frame.



- The wireless touch unit RF Touch is a central controller for heating, switching electrical appliances and equipment, dimming lights, controlling blinds, etc.
- It transmits and receives commands from units and processes set programs for automatic control.
- Thanks to bi-directional communication, it visualizes the current status of individual units.
- Automatic control based on weekly program.
- Touch 3.5" color display.
- It is possible to combine up to 40 units of iNELS RF Control + 30 Oasis detectors (you can gradually expand the installation from 1 unit).
- Power to the touch unit is in the range 100-230 V AC, (RF Touch/W also supplied via adapter 12 V DC (included in the supply).
- RF Touch/W: wall mounting, secured in an installation box or glued to glass, wood, dry wall, etc.
- RF Touch/B: mounting of unit in installation box.
- Range up to 100 m (in open space), if the signal is insufficient between the RF Touch and unit, use the signal repeater RFRP-20.
- Communication frequency with bidirectional protocol iNELS RF Control .
- Color design of RF Touch:
 - frames: in basic plastic design (white, black, red) or in the luxury design LOGUS⁹⁰ - glass, metal (aluminum, nickel, titanium).
 - intermediate frames: in basic white and dark gray with metallic coat - aluminum, pearl, ice and gray.
 - rear cover: in white, ivory, light gray and dark gray
- You can choose your own color combination at e-shop ELKO EP.

In 2011, the RF Touch wireless unit won the prize GOLDEN AMP.

- Colour combination of your choice, you can choose at the ELKO EP e-shop.



black / white

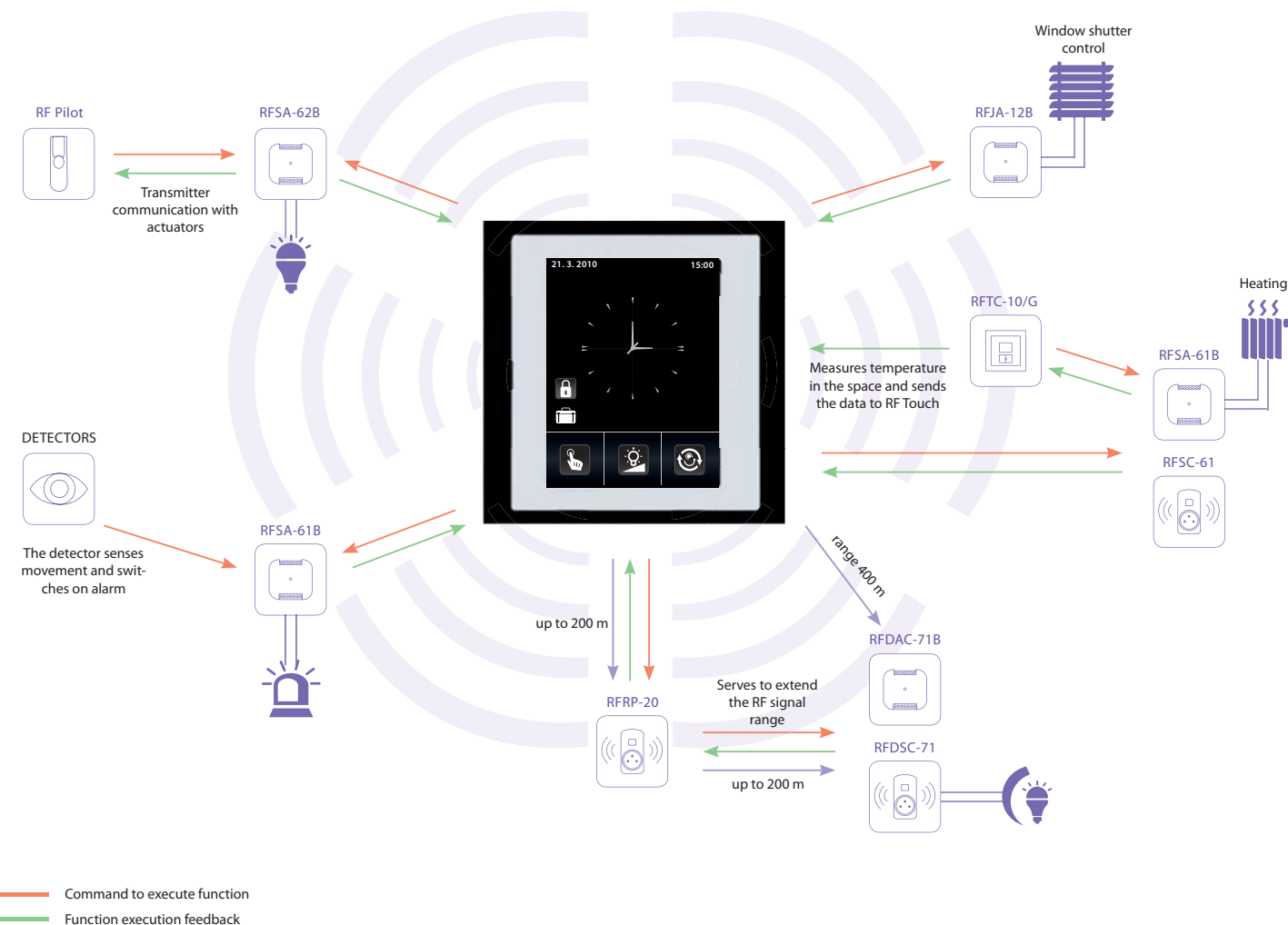

HEATING

- control of heating devices (boilers, thermo valve 0–10 V...)
- temperature regulation in the entire house or in individual rooms
- information about outdoor temperature (wireless temperature sensor) - terraces
- possibility to set your own heating program for the whole week
- holiday mode will interrupt the heating program when you are on holiday
- room temperature correction (during the heating program) is performed with a digital thermal regulator command

DIMMING

- the regulation of light intensity (light bulbs, LED bulbs, LED strips, halogen lights with electrical or coil transformer, fluorescent tubes with dimmable control gear 1–10 V)
- customizable names of individual dimmed circuits (such as "living room lights")
- "sunrise/sunset" imitation - light gradually goes on or off during the preset period between 2 seconds and 30 minutes

DETECTORS

- RF Touch communicates with detectors - window, door, movement...
- possible to combine with switching actuators
- clear control over the entire house

SWITCHING

- this function serves to switch on/off lights, sockets, electrical appliances and devices
- intuitive control thanks to customized name options
- switch clock enabling you to switch appliances in real time, even during your absence (simulation of the presence of persons, etc.)
- switching actuator function selections: switch on/off, impulse relay, button, delayed ON/OFF (time of delay from 2 seconds to 60 minutes)

WINDOW SHUTTERS

- controlling window shutters, sunblinds, blinds, garage door, etc.
- window shutters are controlled separately or as a group
- setting an independent time schedule for pulling up/down
- the window shutter receivers are powered by either 230 V or 24 V DC (shutters between windows, etc.)

QUICK CONTROL

- serves to control group of actuators with a single touch
- possibility to set up scenes; on activation, for example, window shutters are pulled down and lights are adjusted to required intensity



eLAN-RF-003

eLAN-RF-Wi-003

Technical parameters	eLAN-RF-003	eLAN-RF-Wi-003
Interface RF Control		
Communication protocol:	RF Touch Compatible	
Broadcasting frequency	866 MHz, 868 MHz, 916 MHz	
Signal transfer method:	two-way addressed message	
Output for antenna:	SMA connector*	
Antenna RF:	1 dB (part of supply)	
Indications RF communications:	1 x red RF status LED	1 x green RF status LED
Range in free space:	up to 100 m	
Interface Ethernet		
ETH operating status indicator:	green LED	
ETH communication indicator:	yellow LED	
Communications interface:	100 Mbps (RJ45)	
Preset IP address:	192.168.1.1	
Interface Wi-Fi		
Standard:	x	IEEE 802.11 b/g/n / 2.4 GHz
Wi-Fi Security:	x	WEP, WPA-PSK, WPA2-PSK
Frequency range Wi-Fi:	x	R-SMA
Antenna Wi-Fi:	x	1 dB (part of supply)
Indications Wi-Fi communication:	x	1 x red Wi-Fi status LED
Range:	x	in to 200 m
Supply voltage/current:	10-27 V DC / 200 mA SELV	10-27 V DC / 300 mA SELV
Power:	adapter with connector Jack Ø 2.1 mm (part of supply) or connector USB-B	
Supply voltage indication:	green LED POWER	
Button RESET:	settings to their defaults	
Power source:	230 VAC / 12V DC part of supply of device	
Operating conditions		
Operating temperature:	-20 to +50 °C	
Storage temperature:	-25 to +70 °C	
Protection:	IP20	
Contamination degree:	2	
Working position:	any	
Dimensions:	90 x 52 x 65 mm	
Weight:	136 g	145 g

* Max Tightening Torque for antenna connector is 0.56 Nm.

- The smart RF box enables you to control your electrical installation by smartphone, tablet or SMART TV.
- It transmits and receives commands of up to 40 units, and it processes set programs for automatic control, (you can gradually expand installation from 1 unit iNELS RF Control).
- Thanks to bi-directional communication, it visualizes the current status of individual units.
- The smart RF box eLAN-RF-003 is connected by network cable LAN to the home network (router) and communicates with your smart phone.
- The smart RF box eLAN-RF-Wi-003 is connected to the home network (router) via the Wi-Fi network and communicates with your smart phone. Connection to the home network is also possible via network LAN cable.
- The intuitive application environment offers central control from one place.
- Function of application iHC-MAIRF / iHC-MIIRF:
 - control of hot water or electric underfloor heating
 - measuring temperature by wireless sensors
 - switching appliances (garage door, blinds, fan, sprinklers, sockets, etc.)
 - dimming lights (LED, energy-saving, halogen or classic lamps)
 - time switching (delayed switching off of light when leaving room)
 - video camera integration
 - light scenes (make multiple commands at once with a single press).
- If you don't have a fixed IP address, the Smart RF box will obtain it from DHCP server automatically.
- Power is supplied to the Smart RF box via adapter 10-27 V DC (included in the supply) or PoE by power source (router) 24 V DC.
- By connecting two Smart RF boxes by LAN cable, you avoid the problem of lack of signal range.
- Option of setting via web interface or directly in the application iHC-MAIRF (Android) / iHC-MIIRF (iPhone).
- The package includes an internal antenna AN-I, in case the Smart RF box is located in a metal switchboard, you can use the external antenna AN-E for better signal reception.
- Range up to 100 m (in open space), if the signal is insufficient between the Smart RF box and unit, use the signal repeater RFRP-20.
- Communication frequency with bidirectional protocol iNELS RF Control.

Device description

eLAN-RF-Wi-003

Front panel

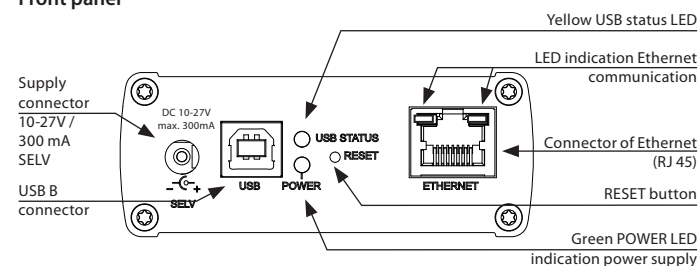

Back panel

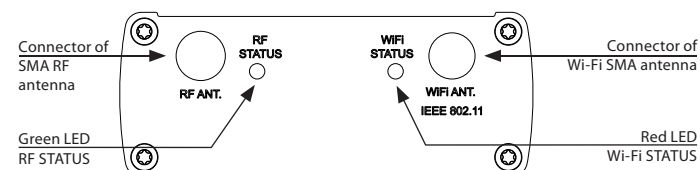

Control apps

Smartphones



iHC-MAIRF

iHC-MIIRF

- Control application for smart phones with Android operating system - iHC-MAIRF and for smart phones iPhone - iHC-MIIRF
- The application iHC-MAIRF / iHC-MIIRF allows you to control your home easily by smartphone.
- The user-friendly and intuitive application environment offers central control from one place.
- iHC-MAIRF / iHC-MIIRF enables control of RF units by smart phone via a smart RF box, which is connected to the home Internet network.
- The smart RF box controls up to 40 units of iNELS RF Control, (you can gradually expand control from 1 unit of iNELS RF Control).
- If you don't have a permanently set IP address, the application supports its automatic obtaining from the DHCP server.
- Functions of the application iHC-MAIRF / iHC-MIIRF:
 - regulation of hot water or electric underfloor heating (setting a weekly program)
 - measuring temperature (e.g. by wireless sensors)
 - switching appliances (garage door, blinds, fans, sprinklers, sockets, etc.)
 - dimming lights (LED, energy-saving, halogen lamps or classic light bulbs)
 - time switching (delayed switching off of light when leaving room)
 - integration of video cameras
 - light scenes (one press to perform multiple commands simultaneously)
 - remote control (switch on heating before returning from vacation).
- The application iHC-MAIRF supports Android versions from 2.3 in your smartphone.

Smart TV



- RF Smart box (eLAN-RF ...) allows remote devices to control a SMART TV.
- Operation with conventional control of TV.
- Compatible with every Smart TV, which has an integrated web browser.
- In the Web browser you enter the IP address of the smart RF box.
- The environment is an intuitive interface where you can insert photos in the background and the locations of the icons to get an overview of the controlled devices in an area.
- Feedback on the switching component is indicated by green colour in the icon.
- Functionality:
 - Switching ON / OFF, automatic timing,
 - Dimming ON / OFF, smooth start / stop, change colour,
 - Scenes
 - Form of heating temperature indication (to make changes directly in the smart phone application)
 - Camera (possibility to stream live images if it is supported by a Web browser on the SMART TV).
- Form control is free and is not licensed.

Smart watch Samsung GEAR S2 / S3



TIZEN iHC-WTRF

- Applications to control appliances via smart watches Samsung Gear S2 / S3.
- Smart watches are associated with the controlled appliances through RF smart box eLAN-RF.
- Functionality:
 - Switching appliances, sockets,
 - Automatic timing,
 - Dimming the lights, adjust the colour,
 - Control garage doors, gates, gates and shutters,
 - Features scenes for group commands.
- Intuitive and easy to control in many combinations, touching the display and moving wheels on Samsung Gear S2 / S3.
- The setting is done by applying iNELS Home Control iHC-MAIRF directly or via a web interface RF smart box eLAN-RF.
- It is not necessary to carry a smart phone to control, the watch functions independently.



Technical parameters		RFGSM-220M
Power		
Supply voltage:	11-30 V DC;	backup power supply Li-Ion batteries
Maximum power consumption:	1 W in standby mode /	power supply and communication max. 18 W
Current consumption:	90 mA at 12 V DC	
Consumption during communication:	max. 1.5 A at 12 V DC	
Working band of GSM module:	850/900/1800/1900 MHz	
Transmitter output power:	2 W for GSM 900, 1 W for GSM 1800	
Inputs IN1, IN2, IN3, IN4		
Control voltage:	AC 12-230 V or DC 12-230 V	(separated optocoupler)
Control input power:	AC 0.025 VA/ DC 0.1 W	
Length of control impulse:	min. 50 ms/ max. unlimited	
Inputs RF:	one-/two-way addressed message	866 MHz, 868 MHz, 916 MHz
Outputs		
Number of contacts:	2x Switches (AgSnO ₂)	
Rated current:	8 A / AC1	
Switching power:	2500 VA, 240 W	
Min. switching power DC:	500 mW	
Mechanical service life (AC1):	1x10 ⁷	
Electrical service life:	1x10 ⁵	
RF outputs:	two-way addressed message	866 MHz, 868 MHz, 916 MHz
Other data		
Operating system PC:	MS Windows XP and higher	
Range of RF module:	up to 150 m	
Output for antenna:	SMA connector*	
Operating temperature:	- 15 up to + 50°C	
Operating position:	any	
Mounting:	DIN rail EN 60715	
Protection:	IP 20 from front panel	
Overvoltage category:	II.	
Contamination degree:	2	
Cross-section of connecting wires (mm ²):	max. 1x 2.5; max. 2x 1.5 /	with a hollow max. 1x 2.5
Dimensions:	90 x 52 x 65 mm	
Weight:	198 g	
Related standards:	EN 60730-1	

* Max Tightening Torque for antenna connector is 0.56 Nm.

- The multi-function GSM communicator is used for remote switching of heating, lights, gate, garage door, etc.
- GSM communicator can be used in several ways, which can be combined:
 - control by telephone, where a sent SMS or ringing through once switches an internal relay.
 - reacts to 1 of 4 potential free wired inputs (detectors, switches), where it is possible to set a consequent reaction.
 - offers the option of ascertaining the status of units iNELS RF Control (ON/OFF, temperature).
 - control by telephone, where a sent SMS or ringing through once transmits an RF command to the switching unit within range, which then switches something (e.g. heating).
 - security function (switching on the ALARM) in combination with wireless detectors OASIS, where activation / deactivation takes place by ringing through once or by key alarm.
- The three-module design of the unit into a switchboard enables connection of a switched load 2x 8 A (2x 2000 W).
- Settings are performed by SW Connect 1 via mini USB connector
- Li-Ion battery for 30 minute function backup
- The GSM communicator is powered by an adapter in the range 11-30 V DC.
- The package includes an internal antenna AN-I, in case of locating the communicator in a metal switchboard, you can use the external antenna AN-E for better signal reception.
- Range up to 150 m (in open space).
- Communication frequency with bidirectional protocol iNELS RF Control.
- Package includes: 2x internal antenna AN-I, mini USB connector, SW Connect 1, adapter 12 V 6 W.

Device description

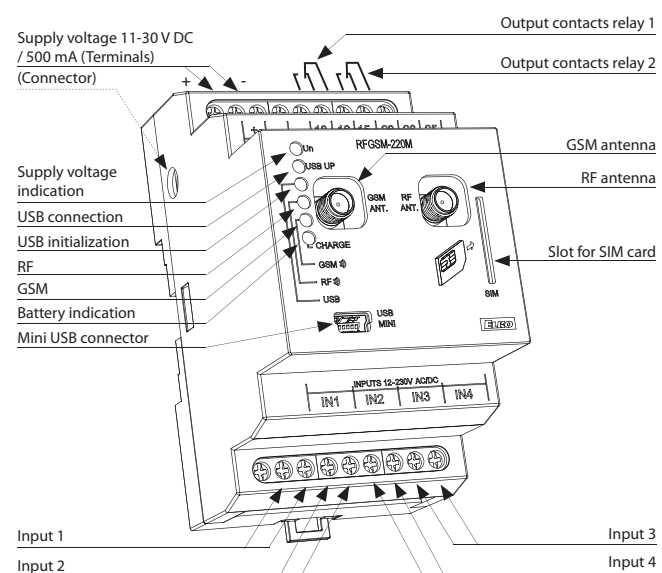

Connection

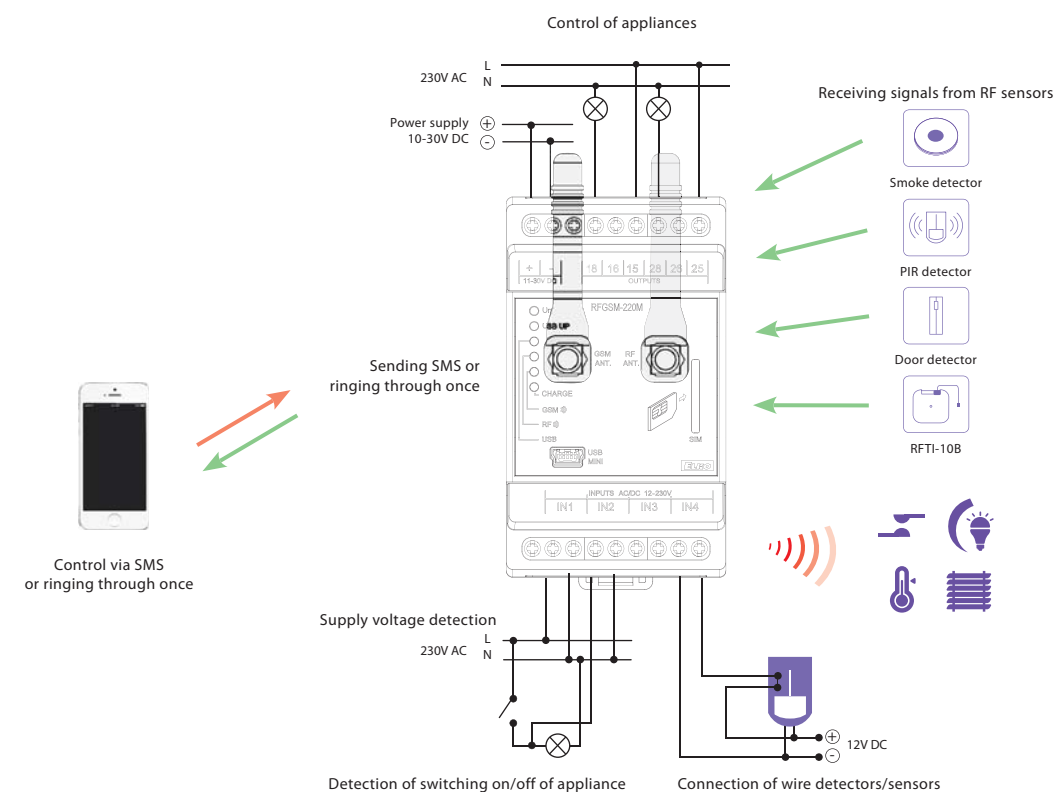

- Command to execute function
- Function execution feedback

A) Thanks to the GSM communicator, you immediately know what the temperature is at home right now. Just send an SMS or ring the communicator once, the RF signal transfers this command to RF Touch and from RF Touch an SMS text message reply is sent back to your phone with the current temperature. You can then switch the heating on or off.

B) By sending an SMS or ringing once, you activate the GSM communicator, which sends an RF command to the temperature actuator, which then switches the heating (cable connection applied between the actuator and heater).

C) GSM communicator enables you to directly switch on up to 4 appliances. Its usefulness thus expands from simply switching into the area of detectors. One of 4 inputs receives information from the detector and sends it by SMS to the given telephone number.

D) GSM communicator features a simple and secure function via dialing or key chain to activate the ARM / DISARM for guarding property. ARM function = guarding. In the case of detection or changes in the detector, the gateway sends a command to switch the siren, and can send an SMS to the set-up number.



- Radio frequency signal repeater
- This signal repeater is used to extend the range between the controller and unit by up to 200 meters.
- It is designed to transmit a signal to up to 20 units.
- Thanks to the socket design, installation is simple by direct insertion into the existing socket, the throughsocket function remains unchanged.
- Indication:
 - green LED - supply voltage
 - red LED - active status (receiving and transmitting an RF signal)
- Programming is performed by a button.
- Communication frequency with bidirectional protocol iNELS RF Control.

• Produced in 5 designs of sockets and plugs:

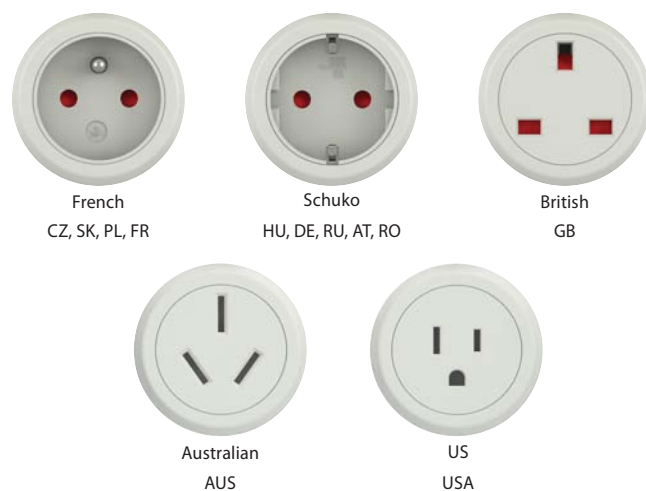

Technical parameters	RFRP-20/230V	RFRP-20/120V
Supply voltage:	230 - 250 V / 50-60 Hz	120 V AC / 60 Hz
Apparent input:	6 VA	
Dissipated power:	0.7 W	
Transmitter frequency:	866 MHz, 868 MHz, 916 MHz	
Range in free space:	up to 200 m	
Minimum control distance:	20 mm	
Programming:	button - green LED / red LED	
Other data		
Operating temperature:	-20 to +55 °C	
Storage temperature:	-30 to +70 °C	
Mounting:	plug into a socket	
Protection:	IP20 Device	
Dimensions:	60 x 120 x 80 mm	
Weight:	225 g	
Related standards:	EN 607 30-1 ED.2	

Controlling up to 20 actuators

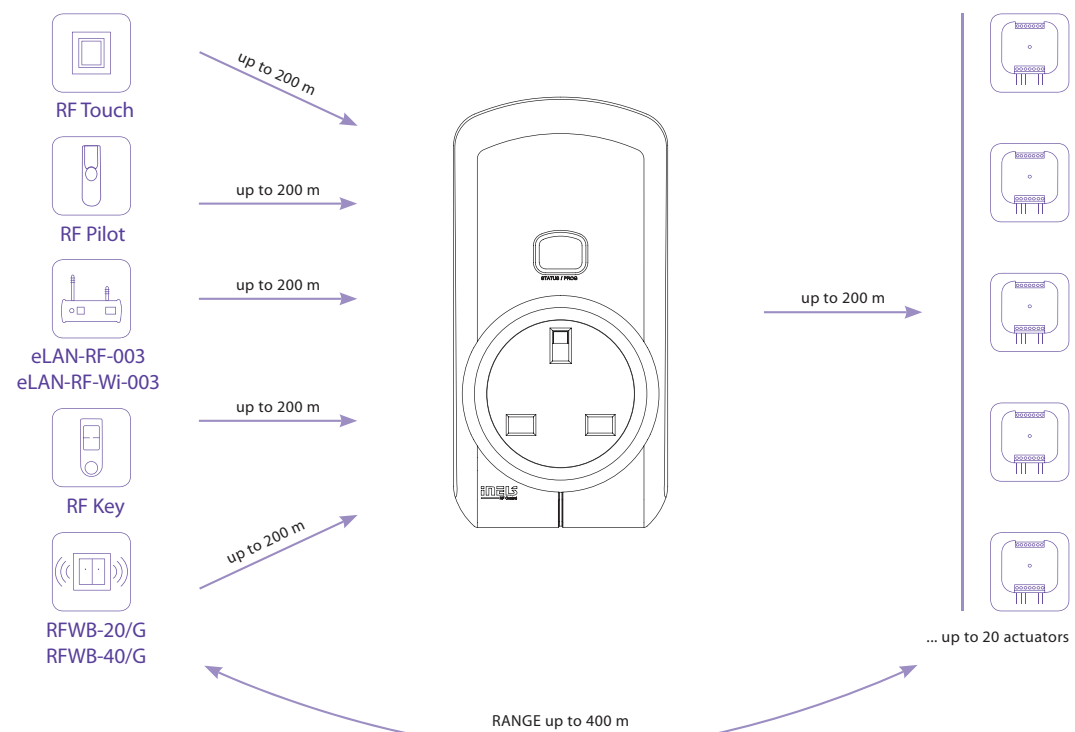

RFSA-11B

RFSA-61B

Technical parameters	RFSA-11B/230V RFSA-61B/320V	RFSA-11B/120V RFSA-61B/120V	RFSA-11B/24V RFSA-61B/24V
Supply voltage:	230 V AC / 50-60 Hz	120 V AC / 60 Hz	12-24 V AC / DC 50-60 Hz
Apparent input:	7 VA / cos φ = 0.1	7 VA / cos φ = 0.1	-
Dissipated power:	0.7 W	0.7 W	0.7 W
Supply voltage tolerance:	+10 %; -15 %		
Output			
Number of contacts:	1x switching (AgSnO ₂)		
Rated current:	16 A / AC1		
Switching power:	4000 VA / AC1, 384 W / DC		
Peak current:	30 A / <3 s		
Switching voltage:	250 V AC1 / 24 V DC		
Max. DC switching power:	500 mW		
Mechanical service life:	3x 10 ⁷		
Electrical service life (AC1):	0.7x 10 ⁵		
Control			
RF, by command from transmitter:	866 MHz, 868 MHz, 916 MHz		
Manual control:	PROG (ON/OFF) button		
Range in free space:	up to 200 m		
Other data			
Operating temperature:	-15 to + 50 °C		
Operating position:	any		
Mounting:	free at lead-in wires		
Protection:	IP30		
Overtoltage category:	III.		
Contamination degree:	2		
Terminals (CY wire, cross-section):	2x 0.75 mm ² , 2x 2.5 mm ²		
Length of terminals:	90 mm		
Dimensions:	49 x 49 x 21 mm		
Weight:	46 g		
Related standards:	EN 60669, EN 300 220, EN 301 489 R&TTE Directive, Order. No 426/2000 Coll. (Directive 1999/EC)		

- The switching unit with 1 output channel is used to control appliances, lights (easy to integrate it to control garage doors or gates).
- It can be combined with Control or System units iNELS RF Control.
- The BOX design lets you mount it right in an installation box, a ceiling or controlled appliance cover.
- It enables connection of the switched load up to 16 A (4 000 W).
- **RFSA-11B:** single-function design - switch on / off.
- **RFSA-61B:** multi-function design - button, impulse relay and time function of delayed ON or OFF with time setting of 2 s-60 min.
- The switching unit may be controlled by up to 25 channels (1 channel represents 1 button on the controller).
- The programming button on the unit is also used for manual control of the output.
- Range up to 200 m (in open space), if the signal is insufficient between the controller and unit, use the signal repeater RFRP-20.
- For components labelled as iNELS RF Control² (RFIO²), it is possible to set the repeater function via the RFAF / USB service device.
- Communication frequency with bidirectional protocol iNELS RF Control² (RFIO²).

Device description

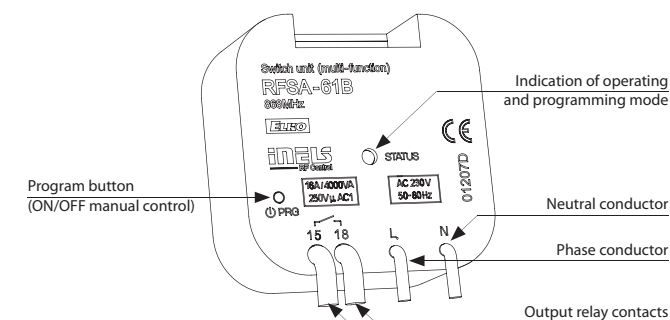

Function

For more information see p. 64.

Connection

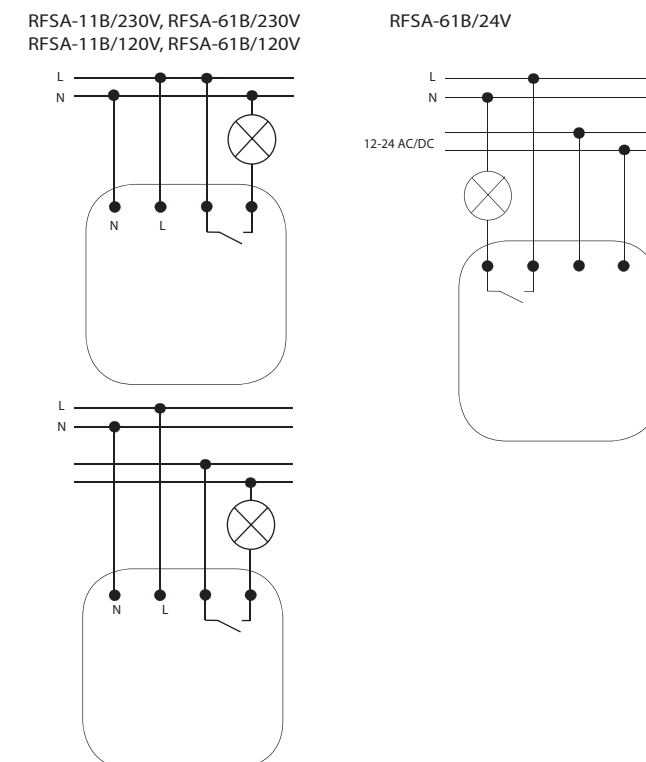



Technical parameters	RFS-62B/320V	RFS-62B/120V	RFS-62B/24V
Supply voltage:	230 V AC / 50-60 Hz	120 V AC / 60 Hz	12-24 V AC / DC 50-60 Hz
Apparent input:	7 VA / $\cos \varphi = 0.1$	7 VA / $\cos \varphi = 0.1$	-
Dissipated power:	0.7 W	0.7 W	0.7 W
Supply voltage tolerance:	+10 %; -15 %		
Output			
Number of contacts:	2 x switching (AgSnO ₂)		
Rated current:	8 A / AC1		
Switching power:	2000 VA / AC1		
Peak current:	10 A / <3 s		
Switching voltage:	250 V AC1		
Max. DC switching power:	500 mW		
Mechanical service life:	1x10 ⁷		
Electrical service life (AC1):	1x10 ⁵		
Control			
RF, by command from transmitter:	866 MHz, 868 MHz, 916 MHz		
Manual control:	PROG (ON/OFF) button		
Range in free space:	up to 100 m		
Other data			
Operating temperature:	-15 to + 50 °C		
Operating position:	any		
Mounting:	free at lead-in wires		
Protection:	IP 30		
Overvoltage category:	III.		
Contamination degree:	2		
Terminals (CY wire, cross-section):	1x 2.5 mm ² , 3x 0.75 mm ²	1x2.5, 4x0.75mm ²	
Length of terminals:	90 mm		
Dimensions:	49 x 49 x 21 mm		
Weight:	46 g		
Related standards:	EN 60669, EN 300 220, EN 301 489 R&TTE Directive, Order. No 426/2000 Coll. (Directive 1999/EC)		

- The switching unit with 2 output channels is used for controlling appliances and light circuits.
- It can be combined with Control or System units iNELS RF Control.
- The BOX design lets you mount it right in an installation box, a ceiling or controlled appliance cover.
- It enables connection of switched load 2x 8 A (2x 2 000 W).
- Function: button, impulse relay and time function of delayed start and return with time setting range of 2 s-60 min.
- It is possible to assign any function to each output relay.
- Each of the channels may be controlled by up to 12/12 channels (1 channel represents 1 button on the controller).
- The programming button on the unit is also used for manual control of the output.
- Range up to 100 m (in open space), if the signal is insufficient between the controller and unit, use the signal repeater RFRP-20.
- For components labelled as iNELS RF Control² (RFIO²), it is possible to set the repeater function via the RFAF / USB service device.
- Communication frequency with bidirectional protocol iNELS RF Control² (RFIO²).

Device description

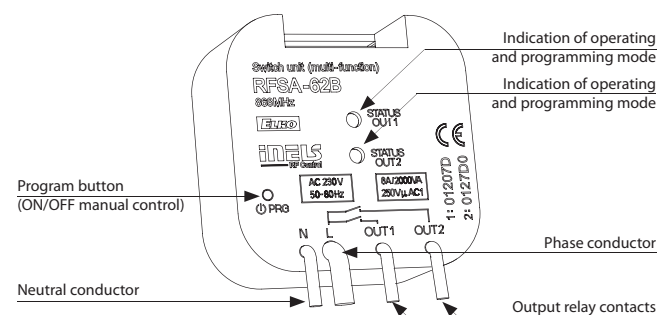

Function

For more information see p. 64.

Connection

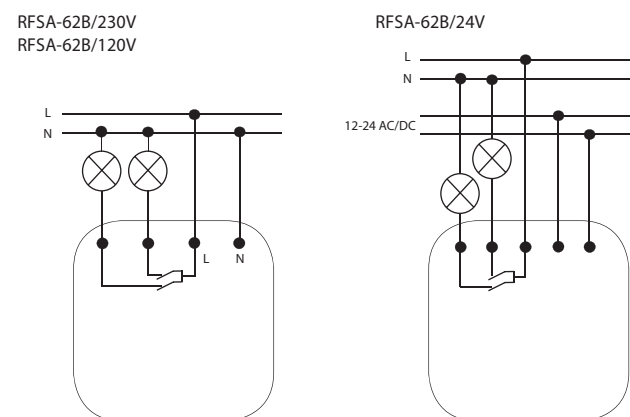

Technical parameters	RFS-61B/230V	RFS-61B/120V	RFS-61B/24V
Supply voltage:	230 V AC / 50-60 Hz	120 V AC / 60 Hz	12-24 V AC / DC 50-60 Hz
Apparent power:	7 VA / $\cos \varphi = 0.1$	7 VA / $\cos \varphi = 0.1$	-
Dissipated power:	0.7 W	0.7 W	0.7 W
Supply voltage tolerance:	+10 %; -15 %		
Output			
Number of contacts:	1x switching (AgSnO ₂)		
Rated current:	16 A / AC1		
Switching power:	4000 VA / AC1, 384 W / DC		
Peak current:	30 A / <3 s		
Switching voltage:	250 V AC1 / 24 V DC		
Min. switching power DC:	500 mW		
Mechanical service life:	3x10 ⁷		
Electrical service life (AC1):	0.7x10 ⁵		
Controlling			
RF command from the transmitter:	866 MHz, 868 MHz, 916 MHz		
Manual control:	button PROG (ON/OFF)		
External button:	max. 12 m cable *		
Range in open space:	up to 200 m		
Other data			
Voltage of open contact:	3 V		
Resist. of connection for closed contact:	<1 kΩ		
Resist. of connection for open contact:	>10 kΩ		
Galvanic isolation of input:	no Δ		
Operating temperature:	15 up to + 50 °C		
Working position:	any		
Mounting:	free at lead-in wires		
Protection:	IP30		
Overvoltage category:	III.		
Contamination degree:	2		
Terminals (CY wire, Cross-section):	2x 0.75 mm ² , 2x 2.5 mm ²		
Terminal length:	90 mm		
Dimensions:	49 x 49 x 21 mm		
Weight:	46 g		
Related standards:	EN 60669, EN 300 220, EN 301 489 R&TTE Directive, Order. No 426/2000 Coll. (Directive 1999/EC)		

* Control button input is at the supply voltage potential.

- The switching unit with 1 output channel is used for controlling appliances and lights. It is possible to connect the existing button to the internal terminal in the wiring.
- It can be combined with Control or System units iNELS RF Control.
- The BOX design lets you mount it right in an installation box, a ceiling or controlled appliance cover.
- It enables connection of the switched load up to 16 A (4 000 W).
- Function: button, impulse relay and time function of delayed start or return with time setting range of 2 s-60min.
- External button is programmed as a wireless button.
- Input is not galvanic isolated.
- The switching unit may be controlled by up to 25 channels (1 channel represents 1 button on the controller).
- The programming button on the unit is also used for manual control of the output.
- Range up to 200 m (in open space), if the signal is insufficient between the controller and unit, use the signal repeater RFRP-20.
- For components labelled as iNELS RF Control² (RFIO²), it is possible to set the repeater function via the RFAF / USB service device.
- Communication frequency with bidirectional protocol iNELS RF Control² (RFIO²).

Device description

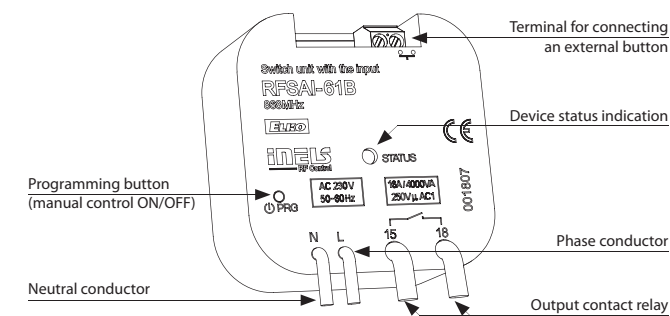

Function

For more information see p. 64.

Connection

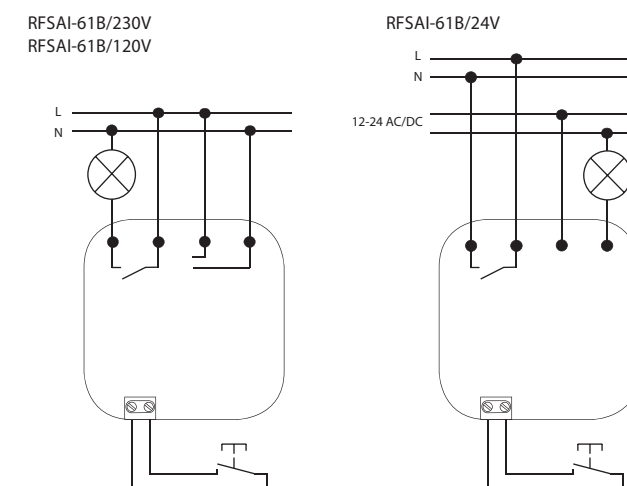



EXTERNAL ANTENNA AN-E

- **RFSA-61M:** the switching unit with 1 output channel is used for controlling appliances, sockets or lights.
 - the one-module design of the unit into a switchboard enables connection of a switched load up to 16 A (4 000 W).
 - the switching unit may be controlled by up to 25 channels (1 channel represents 1 button on the controller).
- **RFSA-66M:** the switching unit with 6 output channels is used for independent control of up to 6 appliances, sockets or lights. It is possible to assign any function to each output relay.
 - the three-module design of the unit into a switchboard enables connection of a switched load 6x 8 A (6x 2000 W).
 - it is just right for creating scenes, where with one push of the controller, you can switch on or off all 6 channels simultaneously.
 - each of the channels may be controlled by up to 25 channels (1 channel represents one button on the controller).
- It can be combined with Control or System units iNELS RF Control.
- The integrated switching contact enables connection, where the controlled appliance may be switched on or off by command.
- Function: button, impulse relay and time function of delayed start or return with time setting range of 2 s-60 min.
- The programming button on the unit is also used for manual control of the output.
- The package includes an internal antenna AN-I, in case of locating the element in a metal switchboard, you can use the external antenna AN-E for better signal reception.
- Range up to 200 m (in open space), if the signal is insufficient between the controller and unit, use the signal repeater RFRP-20.
- For components labelled as iNELS RF Control² (RFIO²), it is possible to set the repeater function via the RFAF / USB service device.
- Communication frequency with bidirectional protocol iNELS RF Control² (RFIO²).

Device description

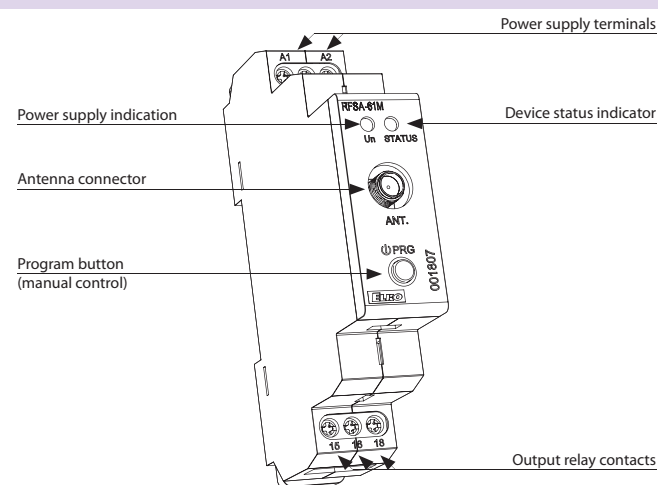

Function

For more information see p. 64.

Connection

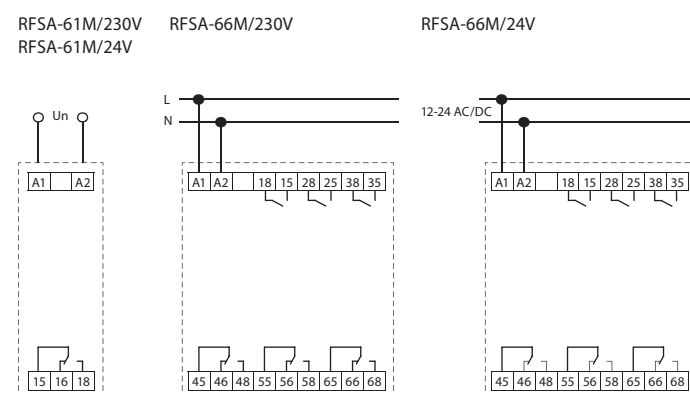

Technical parameters	RFSA-61M/230V	RFSA-61M/24V	RFSA-66M/230V	RFSA-66M/24V
Supply voltage:	110-230VAC / 50-60 Hz	12-24 V AC / DC SELV	10-230 V AC / 50-60 Hz	12-24 V AC / DC SELV
Apparent input:	2.7 VA /	-	min. 2 VA /	-
Dissipated power:	cos φ = 0.6	-	max. 5 VA	-
Supply voltage tolerance:	1.62 W	0.8 W	min. 0.5 W / max. 2.5 W	max. 1.8 W
	+10% / -25 %			
Output				
Number of contacts:	1x changeover (AgSnO ₂)		3x changeover (AgSnO ₂); 3x switching (AgSnO ₂)	
Rated current:	16 A / AC1		8 A / AC1	
Switching power:	4000 VA / AC1, 384 W / DC		2000 VA / AC1	
Peak current:	30 A / <3 s		10 A / <3 s	
Switching voltage:	250 V AC1 / 24 V DC		250 V AC1	
Max. DC switching power:	500 mW		500 mW	
Mechanical service life:	3x10 ⁷		1x10 ⁷	
Electrical service life (AC1):	0.7x10 ⁵		1x10 ⁵	
Control				
RF, by command from transmitter:	866 MHz, 868 MHz, 916 MHz			
Manual control:	PROG (ON/OFF) button			
Range in free space:	up to 200 m			
Output for antenna:	SMA connector*			
Other data				
Operating temperature:	-15 °C to + 50 °C			
Operating position:	any			
Mounting:	DIN rail EN 60715			
Protection:	IP20 from the front panel			
Overvoltage category:	III.			
Contamination degree:	2			
Connecting conductor cross-section (mm ²):	max. 1x 2.5, max. 2x 1.5 / with a hollow max. 1x 2.5			
Dimensions:	90 x 17.6 x 64 mm		90 x 52 x 65 mm	
Weight:	74 g		264 g	
Related standards:	EN 60669, EN 300 220, EN 301 489 R&TTE Directive, Order. No 426/2000 Coll. (Directive 1999/EC)			

* Max Tightening Torque for antenna connector is 0.56 Nm.



Technical parameters	RFSC-61/230V	RFSC-61/120V
Supply voltage:	230 - 250 V / 50-60 Hz	120 V AC / 60 Hz
Apparent power:	6 VA	
Dissipated power:	0.7 W	
Supply voltage tolerance:	+10 %; -15 %	
Output		
Number of contacts:	1x switching (AgSnO ₂)	
Rated current:	16 A / AC1	
Switching power:	4000 VA / AC1, 384 W / DC	
Peak current:	30 A / <3 s	
Switching voltage:	250 V AC1 / 24 V DC	
Min. switching power DC:	500 mW	
Mechanical service life:	3x10 ⁷	
Electrical service life (AC1):	0.7x10 ⁵	
Control		
RF command from the transmitter:	866 MHz, 868 MHz, 916 MHz	
Manual control:	button PROG (ON/OFF)	
Range in open space:	up to 200 m	
Other data		
Operating temperature:	-15 up to + 50 °C	
Working position:	any	
Mounting:	plug into a socket	
Protection:	IP30	
Overvoltage category:	III.	
Contamination degree:	2	
Dimensions:	60 x 120 x 80 mm	
Weight:	195 g	
Related standards:	EN 60669, EN 300 220, EN 301 489 R&TTE Directive, Order. No 426/2000 Coll. (Directive 1999/EC)	

- The switched socket with 1 output channel is used to control fans, lamps, heaters and appliances, which are connected by a power cord.
- They can be combined with either Control or System units iNELS RF Control.
- Thanks to the socket design, installation is simple by direct insertion into the existing socket.
- It enables connection of the switched load up to 16 A (4 000 W).
- RFSC-11: single-function design - switch on / off.
- RFSC-61: multi-function design – button, impulse relay and time function of delayed ON or OFF with time setting of 2s-60 min.
- The switched socket may be controlled by up to 25 channels (1 channel represents 1 button on the controller).
- The programming button on the socket is also used for manual control of the output.
- Range up to 200 m (in open space), if the signal is insufficient between the controller and unit, use the signal repeater RFRP-20.
- Communication frequency with bidirectional protocol iNELS RF Control² (RFIO²).

- Produced in 5 designs of sockets and plugs:

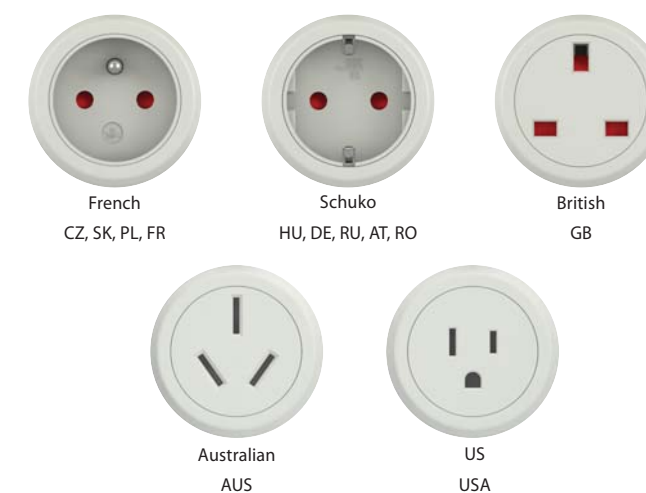

Device description

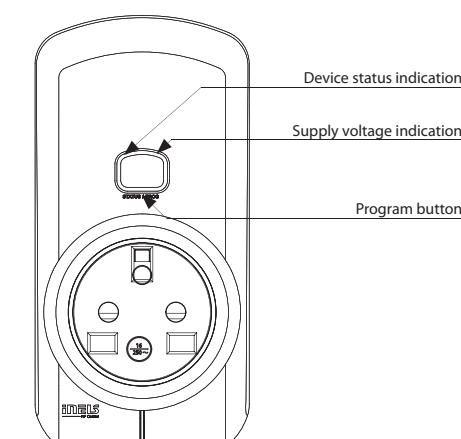

Function

For more information see p. 64.



- The switching unit with 1 output channel is used for controlling appliances, sockets or lights.
- It can be combined with Control or System units iNELS RF Control.
- The increased IP 65 protection is suited to mounting on the wall or in harsh environments such as the cellar, garage or bathrooms.
- It enables connection of the switched load up to 12 A (3.000 W).
- RFUS-61: multi-function design – button, impulse relay and time function of delayed ON or OFF with time setting of 2 s-60 min.
- The switching unit may be controlled by up to 25 channels (1 channel represents 1 button on the controller).
- The programming button on the unit is also used for manual control of the output.
- Range up to 200 m (in open space), if the signal is insufficient between the controller and unit, use the signal repeater RFRP-20.
- For components labelled as iNELS RF Control² (RFIO²), it is possible to set the repeater function via the RFAF / USB service device.
- Communication frequency with bidirectional protocol iNELS RF Control² (RFIO²).

Device description

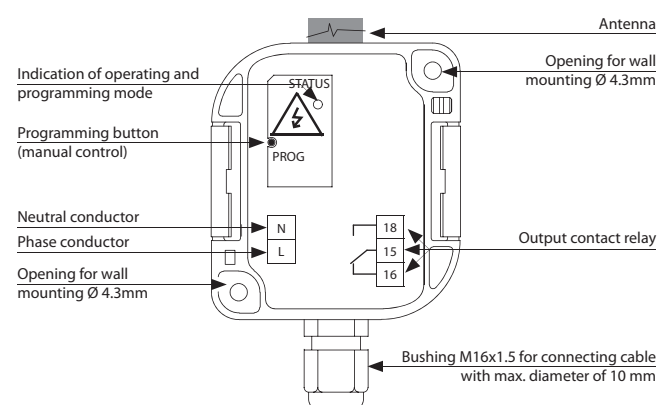

Function

For more information see p. 64.

Connection

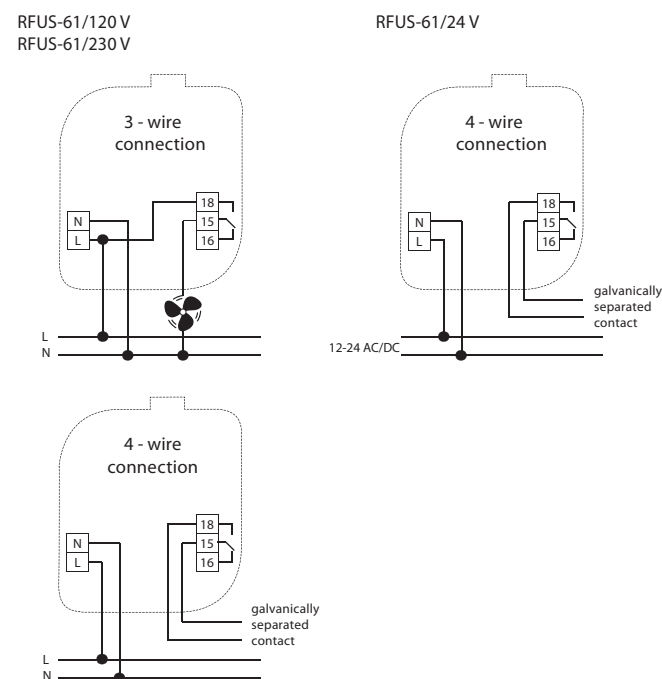

Technical parameters RFUS-61/230V RFUS-61/120V RFUS-61/24V

Supply voltage:	230 V AC / 50-60 Hz	120 V AC / 60 Hz	12-24 V AC/DC 50-60 Hz
Apparent power:	5 VA / cos φ = 0.1	5 VA / cos φ = 0.1	-
Dissipated power:	0.6 W	0.6 W	0.6 W
Supply voltage tolerance:	+10 %; -15 %		

Output

Rated current:	1 x switching (AgSnO ₂)		
Number of contacts:	12 A / AC1		
Switching power:	3000 VA / AC1, 384 W / DC		
Peak current:	30 A / <3 s		
Peak current:	250 V AC1 / 24 V DC		
Min. switching power DC:	500 mW		
Mechanical service life:	3x10 ⁷		
Electrical service life (AC1):	0.7x10 ⁵		

Control

RF command from the transmitter:	866 MHz, 868 MHz, 916 MHz		
Manual control:	button PROG (ON/OFF)		
Range in open space:	up to 200 m		

Other data

Operating temperature:	-15 up to + 50 °C		
Operating position:	any		
Mounting:	screws		
Protection:	IP65		
Overvoltage category:	III.		
Contamination degree:	2		
Cross-section of connecting wires (mm ²):	max. 1x 2.5, max. 2x 1.5 / with a hollow max. 1x 2.5		
Recommended power cord:	CYKY 3x1.5 (CYKY 4x1.5)		
Dimensions:	136 x 62 x 34 mm		
Weight:	146 g		
Related standards:	EN 60669, EN 300 220, EN 301 489 R&TTE Directive, Order. No 426/2000 Coll. (Directive 1999/EC)		



RFJA-12B/230V

RFJA-12B/24VDC

Technical parameters RFJA-12B/230V RFJA-12B/120V RFJA-12B/24V

Supply voltage:	230 V AC / 50 - 60 Hz	120 V AC / 60 Hz	12-24 V DC
Apparent input:	7 VA / cos φ = 0.1	7 VA / cos φ = 0.1	x
Dissipated power:	0.7 W	0.7 W	x
Power without load:	x	x	0.5 W
Power under load:	x	x	25 W
Supply voltage tolerance:	+10 %; -15 %		

Output

Number of contacts:	2 x switching (AgSnO ₂)	x
Rated current:	8 A / AC1	x
Permanent current:	x	1 A
Switching power:	2000 VA / AC1	x
Peak current:	10 A / <3 s	1.5 A
Switching voltage:	250 V AC1	x
Switching output voltage*:	x	12-24 V DC*
Mechanical service life:	1x10 ⁷	x
Electrical service life (AC1):	1x10 ⁵	x

Control

RF, by command from transmitter:	866 MHz, 868 MHz, 916 MHz
Manual control:	PROG (STOP, ▲, STOP, ▼)
Range in free space:	up to 100 m

Other data

Operating temperature:	-15 to + 50 °C	
Operating position:	any	
Mounting:	free at lead-in wires	
Protection:	IP30	
Overvoltage category:	III.	
Contamination degree:	2	
Terminals (CY wire, cross section):	4 x 0.75 mm ²	
Length of terminals:	90 mm	
Dimensions:	49 x 49 x 21 mm	49 x 49 x 13 mm
Weight:	46 g	22 g
Related standards:	EN 60669, EN 300 220, EN 301 489 R&TTE Directive, Order. No 426/2000 Coll. (Directive 1999/EC)	

* Identical with supply voltage

- The switching unit for blinds has 2 output channels used to control garage doors, gates, blinds, awnings, etc.
- It can be combined with Control or System units iNELS RF Control.
- The BOX design lets you mount it right in an installation box, a ceiling or motor drive cover.
- RFJA-12B/230V: connection of switched load 2x 8 A (2x 2 000 W).
- RFJA-12B/24VDC: contactless quiet switching.
- Short presses of the controller enable tilting of lamellas, and a long press enables you to draw the blinds up or down to the end position.
- Each of the units may be controlled by up to 25 channels (1 channel represents 1 button on the controller).
- The programming button on the unit is also used for manual control of the output.
- Range up to 100 m (in open space), if the signal is insufficient between the controller and unit, use the signal repeater RFRP-20.
- For components labelled as iNELS RF Control² (RFIO²), it is possible to set the repeater function via the RFAF / USB service device.
- Communication frequency with bidirectional protocol iNELS RF Control² (RFIO²).

Device description

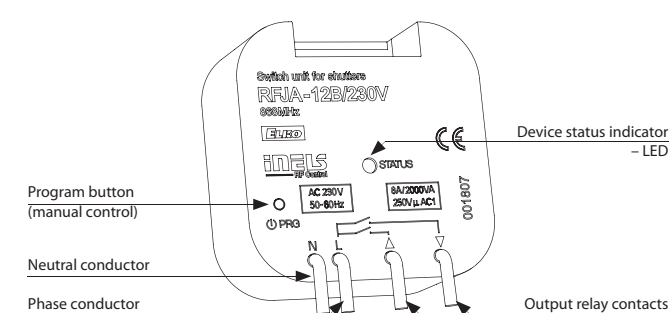

Function description

1. When the control button is pressed for less than 2 seconds, shutters move up (▲) or down (▼).
2. When the control button is pressed for more than 2 seconds, shutters move up (▲) or down (▼) until reaching the final position.

Connection

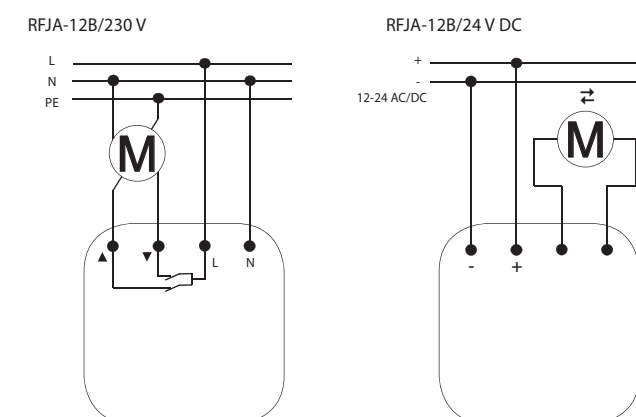



Technical parameters		RFDA-73M/RGB
Supply terminals:		Un+, GND
Supply voltage:		12-24 V DC stabilized
Maximum power without load:		0.8 W
Output		
Dimmed load:		LED strip 12 V, 24 V with common anode RGB LED strips 12 V, 24 V with common anode
Number of channels:		3
Rated current:		3x5 A
Peak current:		3x10 A
Switching voltage:		Un
Control		
RF command from the transmitter:		866 MHz, 868 MHz, 916 MHz
Ext. signal:		0-10 V, 1-10 V
Range in open space:		up to 160 m
Load capacity of output +10V:		10 mA
Output for antenna:		SMA connector*
Other data		
Operating temperature:		-20 up to +50 °C
Storage temperature:		-30 up to +70 °C
Working position:		any
Mounting:		DIN rail EN 60715
Protection:		IP 20 from front panel
Contamination degree:		2
Cross-section of connecting wires (mm ²):		max. 1x 2.5, max. 2x 1.5 / with a hollow max. 1x 2.5
Dimensions:		90 x 52 x 65 mm
Weight:		130 g
Related standards:		EN 60730-1; EN 60730-2-11

* Max Tightening Torque for antenna connector is 0.56 Nm.

- The dimmer for LED strips is used for independent control of 3 single-color LED strips or one RGB LED strip.
- The expanded selection of control modes enables it to be combined with:
 - Controllers and System units iNELS RF Control
 - control signal 0(1)-10 V
 - connecting to iNELS BUS using DAC converters.
- The unit's three-module design with switchboard mounting enables connection of dimmed load 3x 5 A, which represents:
 - single-color LED strip 7.2 W (ELKO Lighting) – 3x 8 m
 - RGB LED strip 14.2 W (ELKO Lighting) – 10 m.
- 6 light functions - smooth increase or decrease with time setting 2 s-30 min.
- When switched off, the set level is stored in the memory, and when switched back on, it returns to the most recently set value.
- The dimmer may be controlled by up to 32 channels (1 channel represents 1 button on the controller).
- The power supply of the unit is in the range of 12-24 V DC, and is indicated by a green LED.
- The package includes an internal antenna AN-I, in case of locating the unit in a metal switchboard, you can use the external antenna AN-E for better signal reception.
- Range up to 160 m (in open space), if the signal is insufficient between the controller and unit, use the signal repeater RFRP-20.
- For components labelled as iNELS RF Control² (RFIO²), it is possible to set the repeater function via the RFAF / USB service device.
- Communication frequency with bidirectional protocol iNELS RF Control² (RFIO²).

Device description

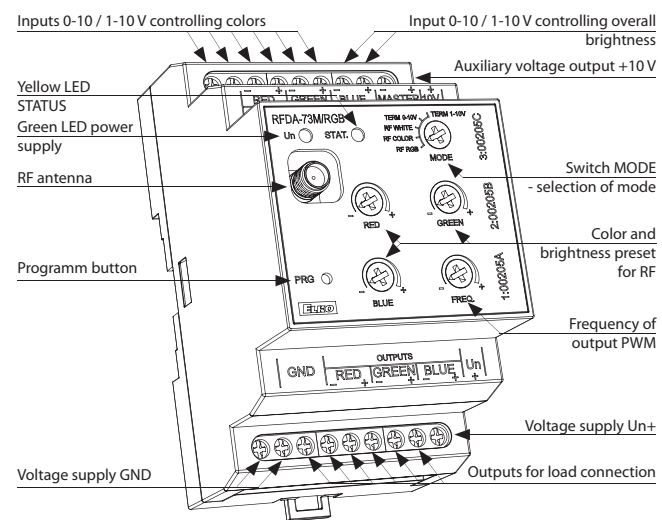

Function

For more information see p. 65.

Output variations

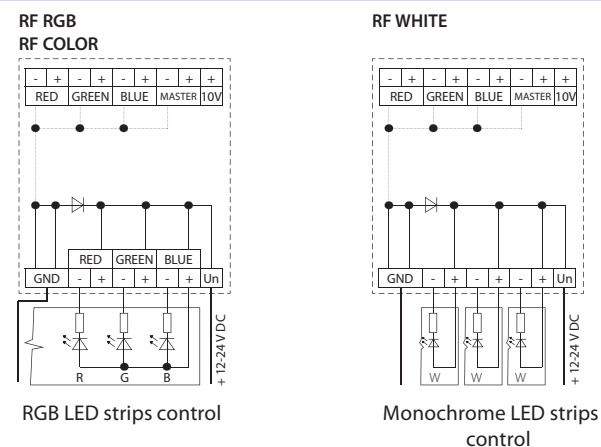

Control modes

RF RGB

Switch settings in MODE:

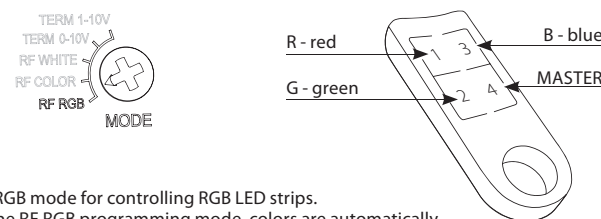

RF RGB mode for controlling RGB LED strips. In the RF RGB programming mode, colors are automatically assigned to individual transmitter buttons.

Note: The mode can be controlled by RF Touch, RF Pilot, RFWB-40/G, RF KEY, RFIM-40B, eLAN-RF-003 and eLAN-RF-Wi-003.

RF WHITE

Switch settings in MODE:

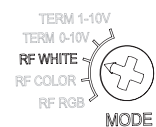

This works in a mode where it acts like three independent dimmers for 12-24 V. Each channel can be programmed independently of one another and has its own address.

Note: The mode can be controlled by RF Touch, RF Pilot, RFWB-20/G, RFWB-40/G, RF KEY, RFIM-20B, RFIM-40B, eLAN-RF-003 and eLAN-RF-Wi-003.

Control options

TERM 0(1)-10 V DC - monochrome LED strips

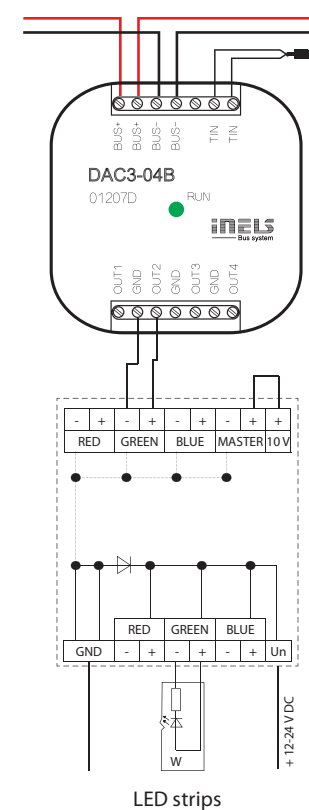

TERM 0(1)-10 V DC - RGB LED strips

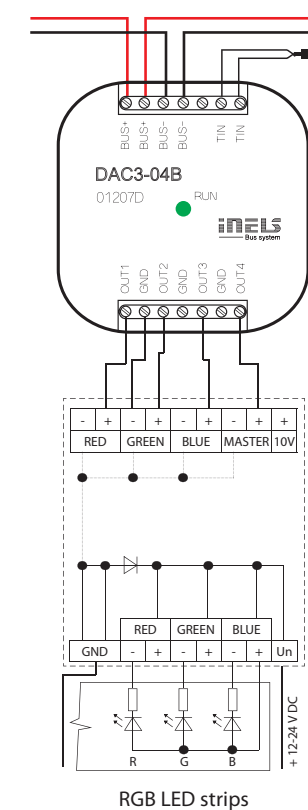

RF COLOR

Switch settings in MODE:

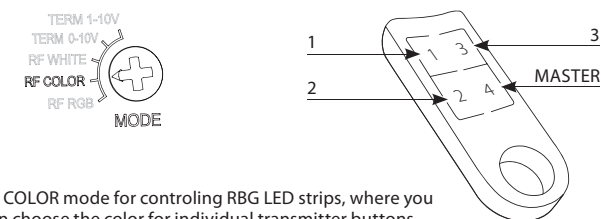

RF COLOR mode for controlling RGB LED strips, where you can choose the color for individual transmitter buttons. A long press of the button starts the color search mode. After releasing the button, the current color is set for the given button.

Note: The mode can be controlled by RF Touch, RF Pilot, RFWB-40/G, RF KEY RFIM-40B, eLAN-RF-003 and eLAN-RF-Wi-003.

TERM 0-10 V and TERM 1-10 V

Switch settings in MODE:



Modes TERM 0-10 V and TERM 1-10 V. Inputs 0-10 V and 1-10 V used to control one RGB LED strip or three independent single-color LED strips (see modes above) from the iNELS BUS System. For controlling, you can use the application IMM on the TV screen or the application iHC for smartphones and tablets.



- The universal built-in dimmer is used to regulate light sources:
 - R – classic lamps
 - L – halogen lamps with wound transformer
 - C – halogen lamps with electronic transformer
 - ESL – dimmable energy-efficient fluorescent lamps
 - LED – LED light sources (230 V).
- It can be combined with Controllers or System units iNELS RF Control.
- The BOX design lets you mount it right in an installation box, a ceiling or light cover.
- 6 light functions - smooth increase or decrease with time setting 2 s-30 min.
- When switched off, the set level is stored in the memory, and when switched back on, it returns to the most recently set value.
- Thanks to setting the min. brightness by potentiometer, you will eliminate flashing of the LED and ESL light sources.
- The universal dimmer may be controlled by up to 25 channels (1 channel represents 1 button on the controller).
- Connection of the existing button on the control input „S“ enables combination of wireless control with classic (wired) control.
- The programming button on the controller is also used for manual control of the output.
- Range up to 160 m (in open space), if the signal is insufficient between the controller and unit, use the signal repeater RFRP-20.
- For components labelled as iNELS RF Control² (RFIO²), it is possible to set the repeater function via the RFAF / USB service device.
- Communication frequency with bidirectional protocol iNELS RF Control² (RFIO²).

Device description

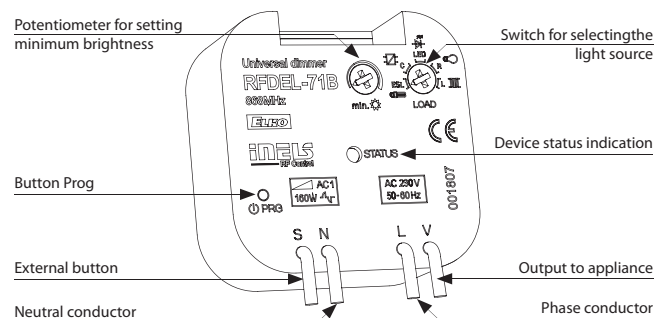

Function

For more information see p. 65.

Connection

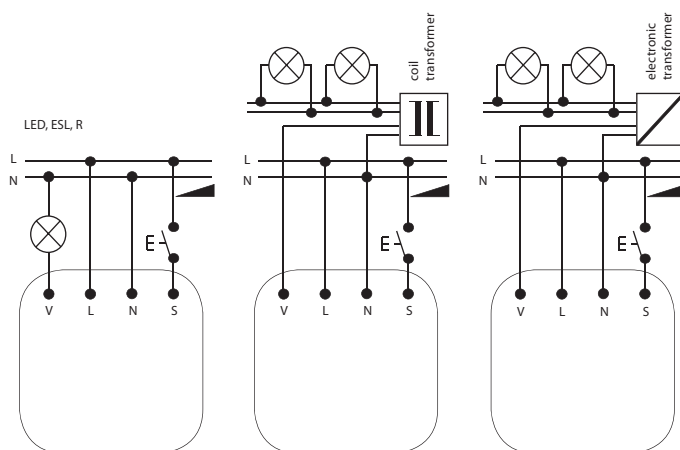

Technical parameters	RFDEL-71B/230V	RFDEL-71B/120V
Supply voltage:	230 V AC / 50 Hz	120 V AC / 60 Hz
Apparent power:	1.1 VA	1.1 VA
Dissipated power:	0.8 W	0.8 W
Supply voltage tolerance:	+10 / -15 %	
Connection:	4-wire, with "NEUTRAL"	
Dimmed load:	R,L,C, LED, ESL	
Output		
Contactless:	2 x MOSFET	
Load capacity:	160 W*	80 W*
Control		
RF command from the transmitter:	866 MHz, 868 MHz, 916 MHz	
Range in open space:	up to 160 m	
Manual control:	button PROG (ON/OFF), external button	
Glow lamp connection:	NO	
Other data		
Operating temperature:	-20 up to + 35°C	
Storage temperature:	-30 up to +70°C	
Operating position:	any	
Mounting:	free at lead-in wires	
Protection:	IP 30 under normal conditions	
Overvoltage category:	III.	
Contamination degree:	2	
Terminals (CY wire, Cross-section):	4 x 0.75 mm ²	
Terminal length:	90 mm	
Dimensions:	49 x 49 x 21 mm	
Weight:	40 g	
Related standards:	EN 607 30-1 ED.2	

* Due to the huge amount of type of light sources, the maximum load depends on internal construction of dimmable LED and ESL bulbs and their power factor cos φ, capacity for power factor cos φ=1. The power factor of dimmable LEDs and ESL bulbs ranges from cos φ = 0.95 up to 0.4. An approximate value of maximum load may be obtained by multiplying the load capacity of the dimmer by the power factor of the connected light source.

You can find the list of dimmable light sources here <http://www.elkoep.com/products/inels-rf-control/dimmers/universal-dimmer-rfdel-71b-8498/>



Technical parameters	RFDEL-71M/230V	RFDEL-71M/120V
Supply voltage:	230 V AC / 50 Hz	120 V AC / 60 Hz
Apparent power:	2.5 VA	1.1 VA
Dissipated power:	0.8 W	0.6 W
Supply voltage tolerance:	+10 / -15 %	
Dimmed load:	R,L,C, LED, ESL	
Output		
Contactless:	2 x MOSFET	
Load capacity:	600 W*	300 W*
Control		
RF command from the transmitter:	866 MHz, 868 MHz, 916 MHz	
Range in open space:	up to 160 m	
Output for antenna:	SMA connector**	
Manual control:	SW (ON/OFF) button, external button, potentiometer	
Glow lamps connection:	NO	
Analog control:	0 (1) - 10 V	
Other data		
Operating temperature:	-20 up to + 35 °C	
Storage temperature:	-30 up to +70°C	
Operating position:	vertical	
Mounting:	DIN rail EN 60715	
Protection:	IP 20 under normal conditions	
Overvoltage category:	II.	
Contamination degree:	2	
Cross-section of connecting wires:	max. 1x 2.5, max. 2x 1.5 / with a hollow max. 1x 2.5	
Dimension:	90 x 52 x 65 mm	
Weight:	125 g	
Related standards:	EN 607 30-1 ed.2	

* Due to the huge amount of type of light sources, the maximum load depends on internal construction of dimmable LED and ESL bulbs and their power factor cos φ, capacity for power factor cos φ=1. The power factor of dimmable LEDs and ESL bulbs ranges from cos φ = 0.95 up to 0.4. An approximate value of maximum load may be obtained by multiplying the load capacity of the dimmer by the power factor of the connected light source.

You can find the list of dimmable light sources here <http://www.elkoep.com/products/inels-rf-control/dimmers/universal-dimmer-rfdel-71m-8501/>

** Max Tightening Torque for antenna connector is 0.56 Nm.

- The universal modular dimmer is used to regulate light sources:
 - R – classic lamps
 - L – halogen lamps with wound transformer
 - C – halogen lamps with electronic transformer
 - ESL – dimmable energy-efficient fluorescent lamps
 - LED – LED light sources (230 V).
- Control can be performed by:
 - Controllers and System units iNELS RF Control
 - by control signal 0(1)-10 V
 - potentiometer
 - existing button in the installation.
- The unit's three-module design with switchboard mounting enables connection of a dimmed load of up to 600 W.
- 6 light functions - smooth increase or decrease with time setting 2 s-30 min.
- When switched off, the set level is stored in the memory, and when switched back on, it returns to the most recently set value.
- Thanks to setting the min. brightness by potentiometer, you will eliminate flashing of the LED and ESL light sources.
- The universal dimmer may be controlled by up to 32 channels (1 channel represents 1 button on the controller).
- The programming button on the controller is also used for manual control of the output.
- The package includes an internal antenna AN-I, in case of locating the unit in a metal switchboard, you can use the external antenna AN-E for better signal reception.
- Range up to 160 m (in open space), if the signal is insufficient between the controller and unit, use the signal repeater RFRP-20.
- For components labelled as iNELS RF Control² (RFIO²), it is possible to set the repeater function via the RFAF / USB service device.
- Communication frequency with bidirectional protocol iNELS RF Control² (RFIO²).

Device description

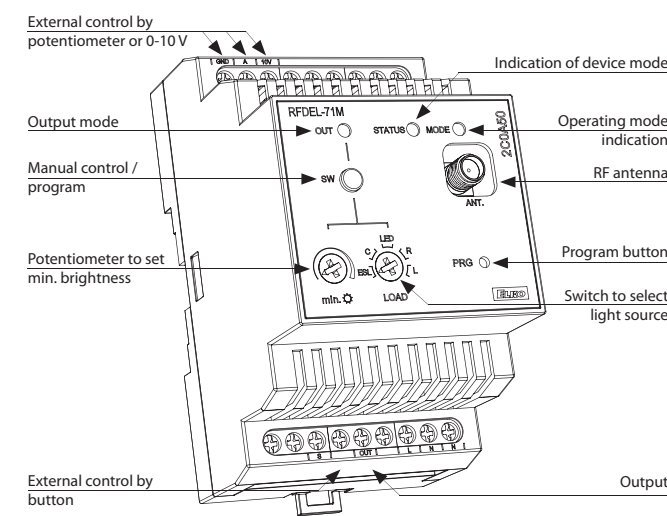

Function

For more information see p. 65.

Connection

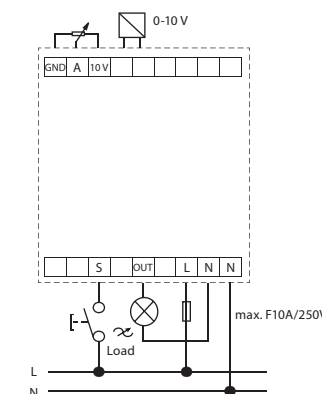

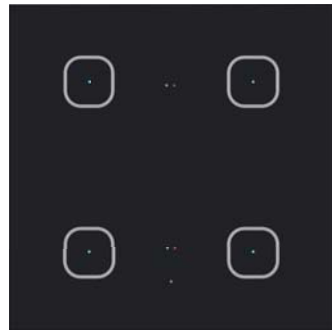

- Wireless glass designed switch with integrated dimming component which serves to regulate light sources:
 - R – classic lamps
 - L – halogen lamps with wound transformer
 - C – halogen lamps with electronic transformer
 - ESL – dimmable energy-efficient fluorescent lamps
 - LED – LED light sources (230 V).
- 4 channel switch version allows you to control the integrated dimmer as well as other components of the installation.
- It can be combined with Controllers or System units iNELS RF Control.
- 6 light functions - smooth increase or decrease with time setting 2 s-30 min.
- When switched off, the set level is stored in the memory, and when switched back on, it returns to the most recently set value.
- Thanks to setting the min. brightness by potentiometer, you will eliminate flashing of the LED and ESL light sources.
- The universal dimmer may be controlled by up to 32 channels (1 channel represents 1 button on the controller).
- The programming button on the controller is also used for manual control of the output.
- Range up to 160 m (in open space), if the signal is insufficient between the controller and unit, use the signal repeater RFRP-20.

Device description

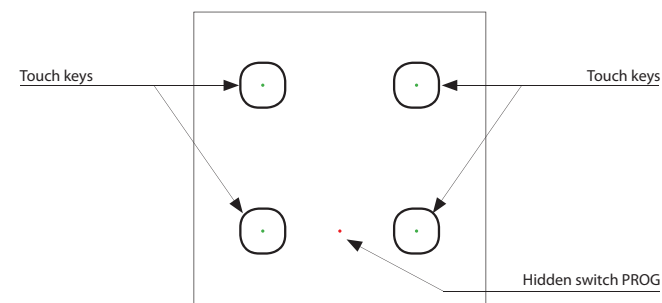

Function

For more information see p. 65.

Connection

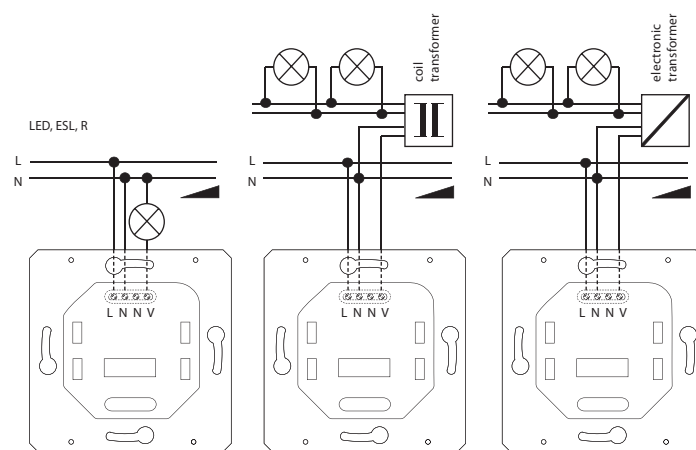

Technical parameters	RFDW-71/230V	RFDW-71/120V
Supply voltage:	230 V AC / 50 Hz	120 V AC / 60 Hz
Apparent power:	1.1 VA	1.1 VA
Dissipated power:	0.8 W	0.8 W
Supply voltage tolerance:	±10 %	
Dimmed load:	R,L,C, LED, ESL	
Input		
Temperature measuring:	YES, built-in temperature sensor	
Scope and accuracy of temp. measurement:	0.. +55°C; 0.3°C from the range	
Output		
Contactless:	2 x MOSFET	
Load capacity:	160 W*	80 W*
Control		
RF command from the detector:	866 MHz, 868 MHz, 916 MHz	
Manual control:	4 touch keys, PROG	
Indications touch keys:	red / green LED	
Indications PROG:	Colour adjustable prog. mode	
Range in open space:	up to 160 m	
Connection		
Terminals:	0.5 - 1 mm ²	
Other data		
Operating temperature:	-20 up to + 35°C	
Storing temperature:	-30 up to +70°C	
Protection degree:	IP 20	
Overvoltage category:	II.	
Pollution degree:	2	
Operation position:	any	
Installation:	into installation box	
Dimensions:	94 x 94 x 36 mm	
Weight:	155 g	

* Due to the huge amount of type of light sources, the maximum load depends on internal construction of dimmable LED and ESL bulbs and their power factor $\cos \varphi$, capacity for power factor $\cos \varphi=1$. The power factor of dimmable LEDs and ESL bulbs ranges from $\cos \varphi = 0.95$ up to 0.4. An approximate value of maximum load may be obtained by multiplying the load capacity of the dimmer by the power factor of the connected light source.



Technical parameters	RFDSC-71/230V	RFDSC-71/120V
Supply voltage:	230 - 250 V / 50-60Hz	120 V AC / 60Hz
Apparent power:	1.1 VA	
Dissipated power:	0.8 W	
Supply voltage tolerance:	+10/ -15 %	
Dimming load:	R, L, C, LED, ESL	
Output		
Contactless:	2 x MOSFET	
Load capacity:	300 W*	150 W*
Control		
RF command from the transmitter:	866 MHz, 868 MHz, 916 MHz	
Range in open space:	up to 160 m	
Manual control:	button PROG (ON/OFF)	
Other data		
Operating temperature:	-20 up to + 35 °C	
Storage temperature:	-30 up to +70°C	
Working position:	any	
Mounting:	plug into a socket	
Protection:	IP30	
Overvoltage category:	III.	
Contamination degree:	2	
Dimensions:	62 x 66 x 102 mm	
Weight:	129 g	
Related standards:	EN 60669, EN 300 220, EN 301 489 R&TTE Directive, Order. No 426/2000 Coll. (Directive 1999/EC)	

* Due to the huge amount of type of light sources, the maximum load depends on internal construction of dimmable LED and ESL bulbs and their power factor $\cos \varphi$, capacity for power factor $\cos \varphi=1$. The power factor of dimmable LEDs and ESL bulbs ranges from $\cos \varphi = 0.95$ up to 0.4. An approximate value of maximum load may be obtained by multiplying the load capacity of the dimmer by the power factor of the connected light source.

You can find the list of dimmable light sources here <http://www.elkoep.com/products/inels-rf-control/dimmers/dimming-socket-singlemulti-function-rfdsc-71-8499/>

- The dimmed socket is used to control light sources that are connected by power cord - especially lamps:
 - R – classic lamps
 - L – halogen lamps with wound transformer
 - C – halogen lamps with electronic transformer
 - ESL – dimmable energy-efficient fluorescent lamps
 - LED – LED light sources (230 V).
- It can be combined with Controllers or System units iNELS RF Control.
- Thanks to the socket design, installation is simple by direct insertion into the existing socket.
- Output load 300 W.
- Multi-function 6 light functions - smooth increase or decrease with time setting 2 s-30 min.
- When switched off, the set level is stored in the memory, and when switched back on, it returns to the most recently set value.
- Thanks to setting the min. brightness by potentiometer, you will eliminate flashing of the LED and ESL light sources.
- The universal dimmer may be controlled by up to 32 channels (1 channel represents 1 button on the controller).
- The programming button on the socket is also used for manual control of the output.
- Range up to 160 m (in open space), if the signal is insufficient between the controller and unit, use the signal repeater RFRP-20.
- Communication frequency with bidirectional protocol iNELS RF Control² (RFIO²).

- Produced in 5 designs of sockets and plugs:

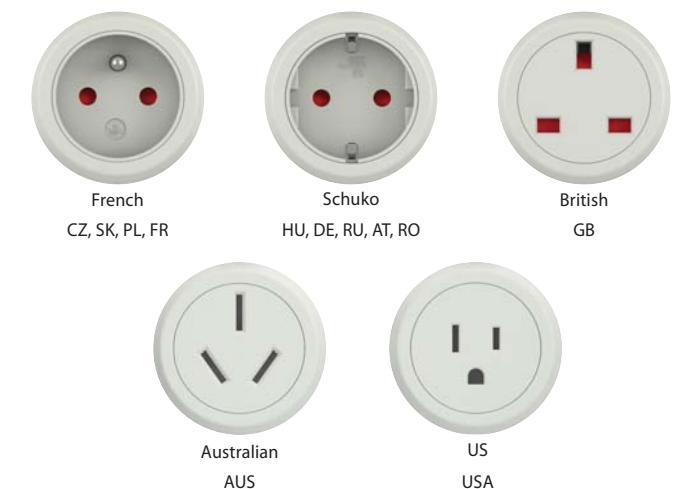

Device description

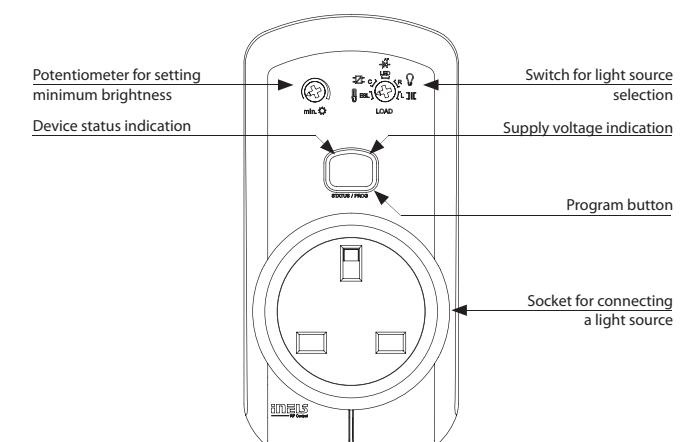

Function

For more information see p. 65.



Technical parameters		RFDAC-71B
Supply voltage:	110 - 230 V AC / 50 - 60 Hz	
Apparent input:	3 VA	
Dissipated power:	1.2 W	
Supply voltage tolerance:	+10 / -15 %	
Potential-free analog output / max. current:	0(1)-10 V / 10 mA	
Control		
RF command from the transmitter:	866 MHz, 868 MHz, 916 MHz	
Manual control:	button PROG (ON/OFF)	
Range in free space:	up to 200 m	
Minimum control distance:	20 mm	
Contact relay:	1x AgSnO ₂ , switches the phase conductor	
Rated current:	16 A / AC1	
Switching power:	4000 VA / AC1	
Switching voltage:	250 V AC1	
Mechanical service life:	3x10 ⁷	
Electrical service life:	0.7x10 ⁵	
Indication:	red LED / green LED	
Output selection:	0(1)-10V / PROG button	
Other data		
Operating temperature:	-15 to + 50 °C	
Operating position:	any	
Mounting:	free at lead-in wires	
Protection:	IP30	
Overvoltage category:	III.	
Contamination degree:	2	
Terminals (CY wire, cross-section):	3 x 0.75 mm ² , 2 x 2.5 mm ²	
Length of terminals:	90 mm	
Dimensions:	49 x 49 x 21 mm	
Weight:	52 g	
Related standards:	EN 60669, EN 300 220, EN 301 489 R&TTE Directive, Order. No 426/2000 Coll. (Directive 1999/EC)	

- The analog controller with output 0(1)-10 V is used for:
 - a) dimming fluorescent lamps (using a dimmable ballast).
 - b) dimming LED panels (when using a suitable dimmed source up to 50 units LP-6060-3K/6K).
 - c) Control of thermal actuators (TELVA).
 - d) control of other controllers (e.g. performance dimmers DIM-6).
- It can be combined with Controllers or System units iNELS RF Control.
- The BOX design lets you mount it right in an installation box, a ceiling or light cover.
- Potential free analog output 10 mA, contact relay 16 A.
- 6 light functions - smooth increase or decrease with time setting 2 s-30 min.
- When switched off, the set level is stored in the memory, and when switched back on, it returns to the most recently set value.
- The analog controller may be controlled by up to 25 channels (1 channel represents 1 button on the controller).
- The programming button on the controller is also used for manual control of the output.
- The unit power supply is in the range 110-230 V AC.
- Range up to 200 m (in open space), if the signal is insufficient between the controller and unit, use the signal repeater RFRP-20.
- For components labelled as iNELS RF Control² (RFIO²), it is possible to set the repeater function via the RFAF / USB service device.
- Communication frequency with bidirectional protocol iNELS RF Control² (RFIO²).

Device description

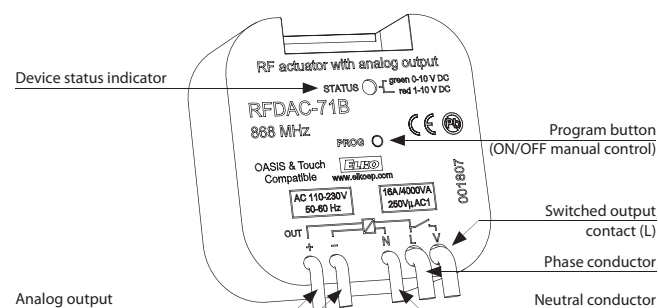

Function

For more information see p. 65.

Connection

Connection example: dimming of fluorescent tubes with dimmable ballast

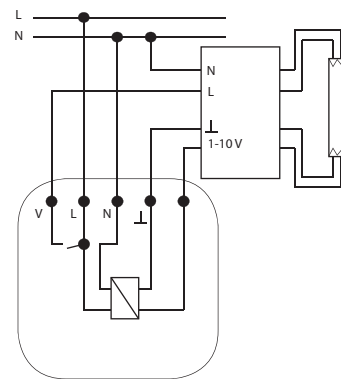

Connection example: with thermo valve

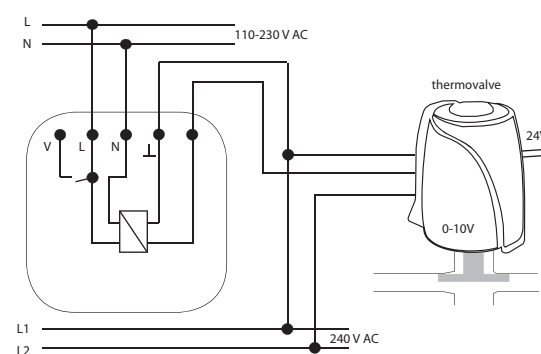

Technical parameters		RF-LED-550	RF-White-LED-675
Supply voltage:	100-240V AC 50/60 Hz		
Maximum power :	9 W	10 W	
Power factor:	<0.6		
Output			
Lighting power:	6 W	8 W	
Luminous flux:	550Lm	675 Lm	
Color temperature:	RGB	2600, 5000	
Brightness regulation:	0-100%		
Durability:	30000 hours		
Controlling			
RF command from the transmitter:	866 MHz, 868 MHz, 916 MHz		
Free space range:	up to 20 m		
Other data			
Operating temperature:	0 to + 50 °C		
Storage temperature:	-30 to + 70 °C		
Connection:	socket E27		
Operating position:	any		
Dimension:	65 x 115 mm		
Weight:	150 g		

RF-LED-550

- The colored lamp with RF module enables you to create an atmosphere for reading, watching a movie, hosting a party with friends, etc.
- The lamp has an implemented wireless unit, which receives commands from system units of iNELS RF Control (link) and sends a signal for visualization of the current status ON/OFF, brightness.
- Luminous flux up to 550 Lm, with power 9 W and life of 30 000 hours.
- RGB lamp function:
 - colored light scenes
 - option of setting brightness in a range of 0-100%
 - circus mode, used for automatic blending of colors

RF-White-LED-675

- The white wireless lamp with RF module is used for everyday illumination.
- The lamp has an implemented wireless unit, which receives commands from system units of iNELS RF Control (link) and sends a signal for visualization of the current status ON/OFF, brightness.
- Luminous flux up to 675 Lm, with power 10 W and life of 30 000 hours.
- White wireless lamp functions:
 - option of setting brightness in a range of 0-100%
 - setting color warm white / cold white.
- When switched off, the set level is stored in the memory, and when switched back on, it returns to the most recently set value.
- Assembly directly in your existing light with base E27.
- The power supply of the lamp is in the range 100-240 V AC.
- Range up to 20 m (in open space); if the signal is insufficient between the controller and unit, use the signal repeater RFRP-20.
- Communication frequency with bidirectional protocol iNELS RF Control.

Dimension

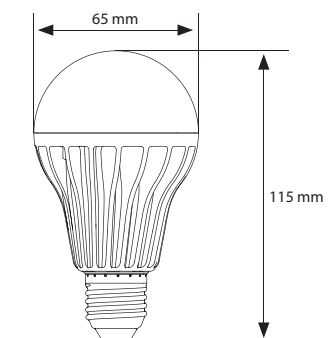



Technical parameters		RFSOU-1
Power supply:	2 x 1.5 battery AAA	
Battery Life:	Appr. 2 years, according to the number of controlled units	
Setting the range of light levels		
Function ☾ (twilight switch)		
- Range 1:	1 ... 10 lx	
- Range 2:	10 ... 100 lx	
- Range 3:	100 ... 1.000 lx	
Function ☀ (light switch)		
- Range 1:	100 ... 1 000 lx	
- Range 2:	1 000 ... 10 000 lx	
- Range 3:	10 000 ... 100 000 lx	
Function setting:	rotary switch	
The level of lighting gently:	0.1 ... 1 x range	
Fine adjustment of lighting levels:	potentiometer	
The time delay t:	0 / 1 min. / 2 min.	
Setting the delay time t:	rotary switch	
Output		
Sending RF communication packet:	866 MHz, 868 MHz, 916 MHz	
Range in free space:	up to 160 m	
Other data		
Working temperature:	-20 to +50°C*	
Storage temperature:	-30 to +70°C	
Operating position:	sensor side down	
Protection:	IP65	
Degree of pollution:	2	
Dimension:	72 x 62 x 34 mm	
Weight:	104 g	
Standards:	EN 60730-1, EN 300 220, EN 301 489 R&TTE Directive, Order. No 426/2000 Coll. (Directive 1999/EC)	

- The wireless twilight dimmer measures the light intensity and based on a set value, it sends the command to switch on the lights or pull the blinds up or down.
- It can be combined with multifunctional switching units and blind switches.
- The increased IP65 protection is suited to mounting on the wall or in harsh environments.
- Integrated sensor for measuring illumination, settable in 3 ranges 1-100,000 lx.
- Selection of function:
 - a) twilight switch – automatically switches on upon a decrease in ambient light intensity, switches off upon an increase (appropriate for garden lights, advertisements, public lighting, etc.).
 - b) light switch – automatically switches on upon an increase in ambient light intensity, switches off upon a decrease (appropriate for offices, restaurants, rooms, etc.).
- Settable delay up to 2 minutes to eliminate unwanted switching caused by surrounding influences.
- The twilight switch may control up to 32 units in the installation.
- The programming button on the regulator is used for:
 - a) setting a function with a switching or blind unit
 - b) ascertaining battery status
 - c) ascertaining signal quality between the unit and dimmer.
- Battery power (1.5 V / 2 x AAA - included in supply) with battery life of around 2 years based on the number of controlled units.
- Range up to 160 m (in open space), if the signal is insufficient between the controller and unit, use the signal repeater RFRP-20.
- Communication frequency with bidirectional protocol iNELS RF Control.

Device description

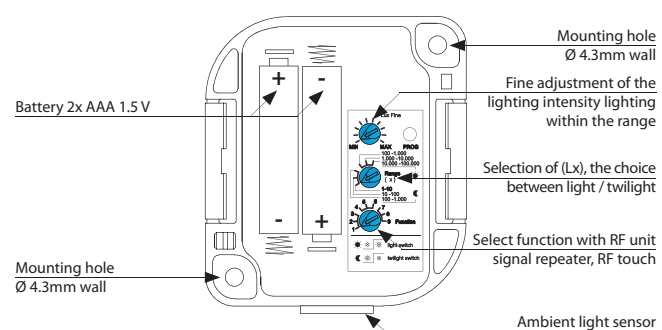

*Note: pay attention to the operating temperature of batteries.



Technical parameters		RFATV-1
Supply voltage:	2x 1.5 V batteries AA	
Battery life:	1 year	
Control		
Broadcasting frequency:	866 MHz, 868 MHz, 916 MHz	
RF command from the transmitter:	RF Touch, eLAN-RF, RFTC-100/G	
Range in open space:	up to 100 m	
Other data		
Operating temperature:	0 up to +50 °C	
Working position:	any	
Protection:	IP40	
Dimensions:	65 x 65 x 48 mm	
Thermostat end:	M 30 x 1.5	
Piston stroke:	max. 4 mm	
Controlling force:	max. 100 N	
Related standards:	EN 60730	

- The wireless thermostat measures room temperature by internal sensor; based on a set program in the system unit, it opens / closes the radiator valve.
- It can be combined with one of three system units: smart RF box eLAN-RF, wireless controller RFTC-100/G or touch unit RF Touch.
- It measures temperature in a range of 0 .. +32°C and sends it to the system unit in regular 5-min. intervals.
- Monitoring function Open window, where upon a sudden change in temperature, it shuts the valve for a preset period.
- Setting the hysteresis and off set is performed in the system unit or application.
- Low battery indicator on the display of the system unit or in the application.
- Mounting directly on the valve of the heater (radiator).
- Battery power (1.5 V / 2x AA - included in supply) with battery life of around 1 year based on frequency of use.
- Range up to 100 m (in open space), if the signal is insufficient between the controller and unit, use the signal repeater RFRP-20.
- Communication frequency with bidirectional protocol iNELS RF Control.
- Package includes: adapters Danfoss RAV, RA, RAVL; 2x batteries AA 1.5 V; key.

Device description

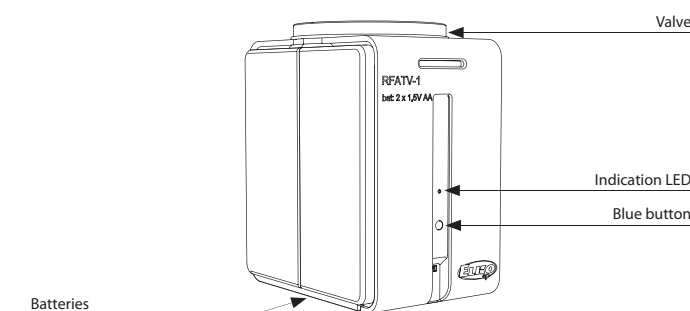

Adapters (is included)

Type of valve	Type of adapter
Danfoss RAV (the valve plunger must be fitted with the enclosed pin):	
Danfoss RA:	
Danfoss RAVL:	



Technical parameters	RFTI-10B
Supply voltage:	1x 3 V CR 2477 battery
Battery life:	1 year
Transmission indication / function:	red LED
Temperature measurement:	1x internal NTC thermistor 1x external TZ/TC temperature sensor input
Temp. measurement range and accuracy:	-20 to +50°C; 0.5 °C in the range
Transmitter frequency:	866 MHz, 868 MHz, 916 MHz
Signal transmission method:	unidirectionally addressed message
Range in free space:	up to 160 m
Other data	
Operating temperature:	-10 to +50 °C
Operating position:	any
Mounting:	glued / free-standing
Protection:	IP30
Contamination degree:	2
Dimensions:	49 x 49 x 13 mm
Weight:	45 g
Related standards:	EN 60669, EN 300 220, EN 301 489 R&TTE Directive, Order. No 426/2000 Coll. (Directive 1999/EC)

- The temperature sensor measures the temperature by internal sensor, which it sends in regular intervals to the system unit. Option of connecting an external sensor to the terminals THERM.
- The temperature sensor can be used in one of two ways:
 - For displaying the measured temperature (from a garage, balcony, cellar, garden) on the display of the system unit or in the application.
 - For measuring temperature, which it sends to the system unit, which may control the heating circuit based on the set temperature program (electric underfloor heating, air conditioning, boiler, etc.).
- It measures temperature in a range of -20-50 °C and sends it to the system unit in regular 5-min. intervals. It sends a signal upon sudden temperature change within 1 min.
- Battery power (3 V / 1x CR 2477 - included in supply) with battery life of around 1 year based on frequency of use.
- The temperature sensor can be placed anywhere thanks to battery power.
- Range up to 160 m (in open space), if the signal is insufficient between the controller and unit, use the signal repeater RFRP-20.
- Communication frequency 868 MHz with bidirectional protocol iNELS RF Control.
- External sensor TC (0 ..+70 °C) or TZ (-40 ..+125 °C) for length of 0.11 m, 3 m, 6 m, 12 m.

Device description

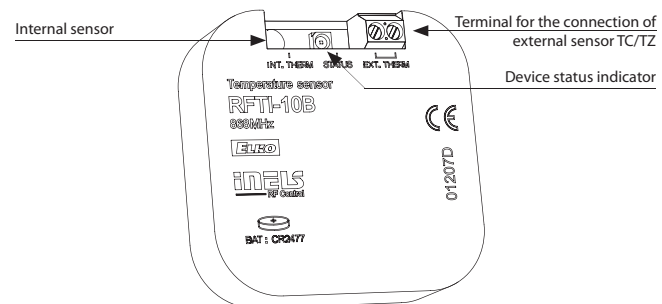

Recommended external sensors

For more information see p. 62.

Sensor location

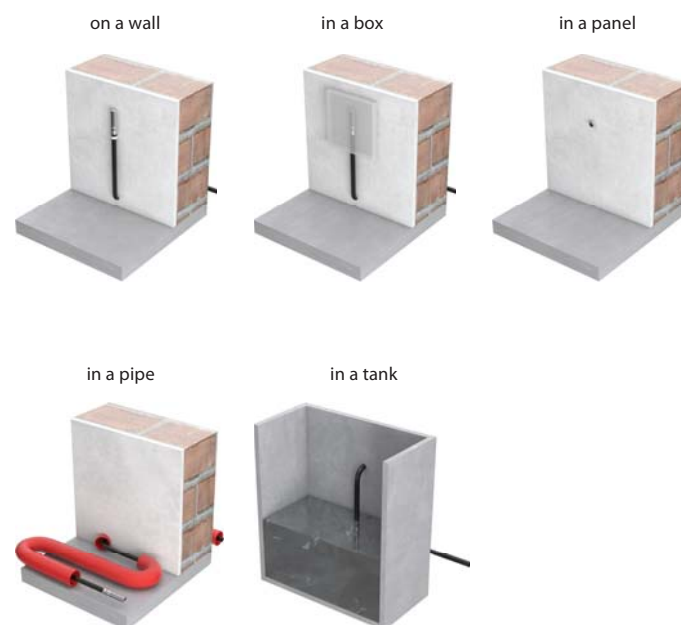

Technical parameters	RFSTI-11B/230V	RFSTI-11B/120V	RFSTI-11B/24V
Supply voltage:	230 V AC / 50-60 Hz	120 V AC / 60 Hz	12-24 V AC/DC
Apparent input:	7 VA / cos φ = 0.1	7 VA / cos φ = 0.1	-
Dissipated power:	0.7 W	0.7 W	0.7 W
Supply voltage tolerance:	+10 %; -15 %		
Temperature measurement input:	1x external TZ/TC temperature sensor input *		
Temp. measurement range and accuracy:	-20 to +50 °C; 0.5 °C of the range		
Output			
Number of contacts:	1x switching (AgSnO ₂)		
Rated current:	16 A / AC1		
Switching power:	4000 VA / AC1, 384 W / DC		
Peak current:	30 A / <3 s		
Switching voltage:	250 V AC1 / 24 V DC		
Max. DC switching power:	500 mW		
Mechanical service life:	3x10 ⁷		
Electrical service life (AC1):	0.7x10 ⁵		
Control			
RF command from the transmitter:	866 MHz, 868 MHz, 916 MHz		
Range in open space:	up to 160 m		
Other data			
Operating temperature:	-15 to +50 °C		
Status indication:	red LED		
Operating position:	any		
Mounting:	free at lead-in wires		
Protection:	IP 30		
Overvoltage category:	III.		
Contamination degree:	2		
Outlets (CY wire, cross-section, length):	2 x 0.75 mm ² , 2 x 2.5 mm ² , 90 mm		
Dimensions:	49 x 49 x 21 mm		
Weight:	46 g		
Related standards:	EN 60669, EN 300 220, EN 301 489 R&TTE Directive, Order. No 426/2000 Coll. (Directive 1999/EC)		

* Temperature sensor input is at the supply voltage potential.

- The temperature unit measures the temperature by external sensor, and controls the heating circuit (electric underfloor heating, air conditioning, boiler, etc.).
- These can be combined with system units: smart RF box eLAN-RF, wireless controller RFTC-50/G or touch unit RF Touch.
- It measures temperature in a range of -20..50 °C and sends it to the system unit in regular 5-min. intervals. It sends a signal upon sudden temperature change.
- Setting the heat/cool function, hysteresis and off set is performed in the system unit or application.
- The BOX design lets you mount it right in an installation box, a ceiling or controlled appliance cover.
- It enables connection of the switched load up to 16 A (4 000 W).
- Range up to 160 m (in open space), if the signal is insufficient between the controller and unit, use the signal repeater RFRP-20.
- For components labelled as iNELS RF Control² (RFIO²), it is possible to set the repeater function via the RFAF / USB service device.
- Communication frequency with bidirectional protocol iNELS RF Control² (RFIO²).
- External sensor TC (0 ..+70 °C) or TZ (-40 ..+125 °C) for length of 0.11 m, 3 m, 6 m, 12 m.

Device description

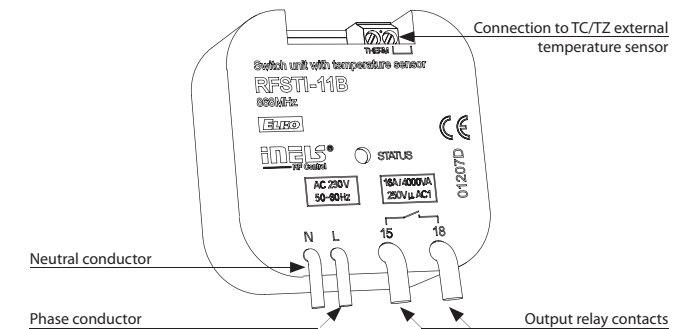

Recommended external sensors

For more information see p. 62.

Connection

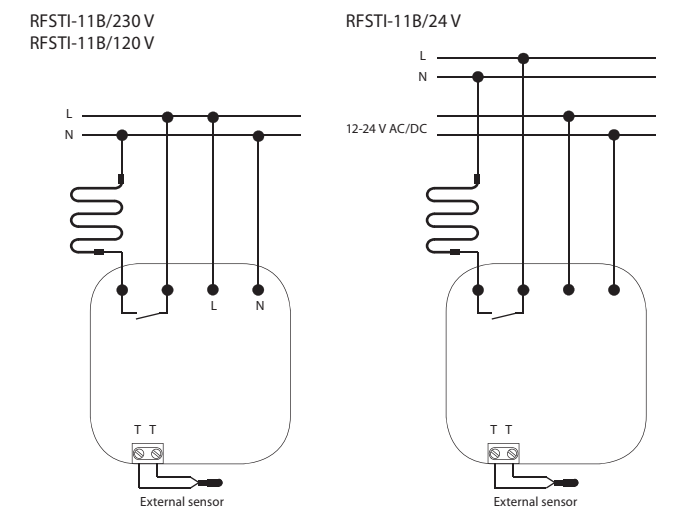

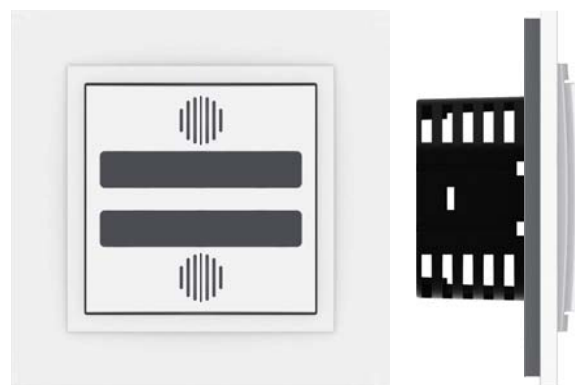

Technical parameters	RFSTI-11/G
Supply voltage:	110-230 V AC / 50 - 60 Hz
Apparent input:	7 VA / cos φ = 0.1
Dissipated power:	0.7 W
Supply voltage tolerance:	+10 %; -15 %
Temperature measurement input:	1x internal NTC thermistor; 1x external TZ/TC temperature sensor input
Temp. measurement range and accuracy:	-20 to +50 °C; 0.5 °C of the range
Output	
Number of contacts:	1x switching (AgSnO ₂)
Rated current:	8 A / AC1
Switching power:	2000VA / AC1; 240W / DC1
Peak current:	30 A / <3 s
Switching voltage:	250 V AC1 / 24 V DC
Max. DC switching power:	500 mW
Mechanical service life:	3x10 ⁷
Electrical service life (AC1):	0.7x10 ⁵
Control	
RF command from the transmitter:	866 MHz, 868 MHz, 916 MHz
Manual control:	buttons
Range in open space:	up to 160 m
Other data	
Operating temperature:	-15 to + 50 °C
Status indication:	blue, red LED
Operating position:	vertical
Mounting:	in an installation box
Protection:	IP 20
Overvoltage category:	III.
Contamination degree:	2
Cross-section of connecting cables (mm ²):	max. 1x 2.5, max. 2x 1.5 / with a hollow max. 1x 2.5
Dimensions:	84 x 89 x 42 mm
Weight:	68 g
Related standards:	EN 60669, EN 300 220, EN 301 489 R&TTE Directive, Order. No 426/2000 Coll. (Directive 1999/EC)

- The thermo-regulation drive measures the (internal / external) temperature by external sensor, and controls the heating circuit (electric underfloor heating, air conditioning, boiler, etc.).
- Function:
 - Internal – measures temperature by internal sensor and sends it to the system unit.
 - External – measures temperature by external sensor and sends it to the system unit.
 - Combo – measure room temperature by internal sensor and monitors critical floor temperature by external sensor.
- These can be combined with system units: smart RF box eLAN-RF or touch unit RF Touch.
- Manual control of temperature directly using buttons on the unit, where by pressing the upper button, a command is sent for automatic switching to the mode Party (preset temperature), and a press of the lower button sends a signal for switching to energy-saving mode (the change in temperature applies until the next set change of the heating program).
- Indication of status switched ON/OFF is provided by (red/blue) LED, which is found under the transparent cover of the temperature unit.
- It measures temperature in a range of -20-50 °C and sends it to the system unit in regular 5-min. intervals. It sends a signal upon sudden temperature change within 1 min.
- Setting the heat/cool function, hysteresis and off set is performed in the system unit or application.
- Switch design (design LOGUS⁹⁰) offers mounting in an installation box.
- It enables connection of the switched load up to 8 A (2 000 W).
- The unit power supply is 110-230 V AC.
- Range up to 160 m (in open space), if the signal is insufficient between the controller and unit, use the signal repeater RFRP-20.
- For components labelled as iNELS RF Control² (RFIO²), it is possible to set the repeater function via the RFAF / USB service device.
- Communication frequency with bidirectional protocol iNELS RF Control² (RFIO²).
- Color combination of heating unit in design of frames LOGUS⁹⁰ (plastic, glass, wood, metal, stone).
- External sensor TC (0 ..+70 °C) or TZ (-40 ..+125 °C) for length of 0.11 m, 3 m, 6 m, 12 m.

Device description

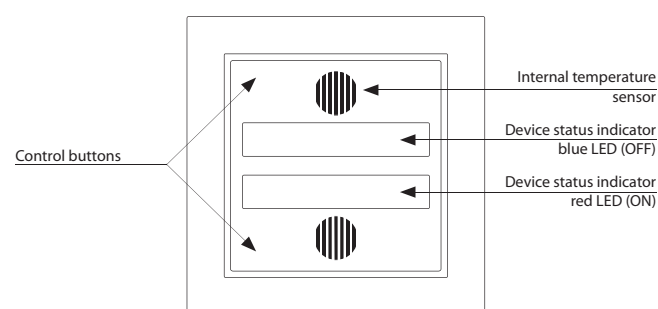

Recommended external sensors

For more information see p. 62.

Connection

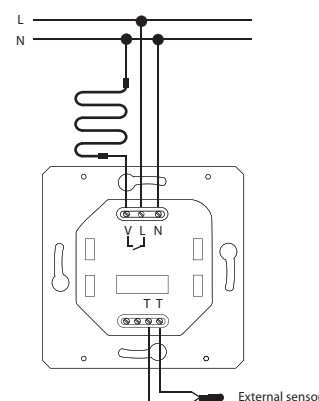

Flat design - the depth of the device is only 20 mm!

Technical parameters	RFTC-10/G			
Supply voltage:	2 x 1.5 V AAA battery			
Battery life:	1 year			
Temperature offset:	2 buttons ∇ / ▲			
Offset:	± 5 °C			
Display:	LCD, characters / see Display description			
Backlighting:	YES / active – blue			
Transmission indication / function:	symbols			
Temperature measurement input:	1x internal sensor			
Temp. measurement range and accuracy:	0 to +55 °C; 0.3 °C of the range			
Transmitter frequency:	866 MHz, 868 MHz, 916 MHz			
Signal transmission method:	bidirectionally addressed message			
Range in free space:	up to 100 m			
Minimum control distance:	20 mm			
Other data				
Max. number of control.				
RFSa-6x:	1			
Program:	x			
Operating temperature:	0 to +55 °C			
Operating position:	wall-mounted			
Mounting:	glue / screws			
Protection:	IP20			
Contamination degree:	2			
Dimensions frame				
- plastic:	85 x 85 x 20 mm			
- metal, glass, wood, granite:	94 x 94 x 20 mm			
Weight:	66 g (without batteries)			
Related standards:	EN 60669, EN 300 220, EN 301 489 R&TTE Directive, Order. No 426/2000 Coll. (Directive 1999/EC)			
Compatibility				
RF Touch	eLAN-RF	RFSa-6 x	RFSTI-11B	RFATV-1
✓	✓	✓	-	-

- The simple controller in design LOGUS⁹⁰ measures the room temperature by internal sensor, and based on the set temperature, it sends a command to control heating.
- The temperature controller can be used in one of two ways:
 - For controlling an additional heat source (heater, oil radiator, radiant panel) with multi-function switching units RFSa-6x, RFUS-61 or RFSC-61.
 - For sufficient temperature correction (± 10 °C) over the course of the program set in the system unit change in temperature applies until the following set change of the heating program in the system unit).
- Manual control by buttons on the unit.
- Range of measured temperature 0-55 °C.
- The backlit LCD display displays the current and set temperature, status (ON/OFF), battery status, etc.
- Battery power (1.5 V / 2x AAA - included in supply) with battery life of around 1 year based on frequency of use.
- The flat rear side of the device enables its placement anywhere in the room where you wish to measure temperature.
- Range up to 100 m (in open space), if the signal is insufficient between the controller and unit, use the signal repeater RFRP-20.
- Communication frequency with bidirectional protocol iNELS RF Control
- Color combination of heating unit in design of frames LOGUS⁹⁰ (plastic, glass, wood, metal, stone).

Device description

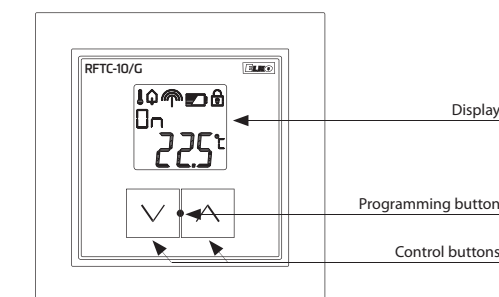

Display description

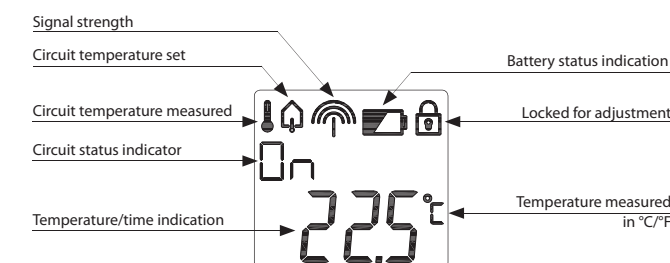



Flat design - the depth of the device is only 20 mm!

- The wireless controller in design LOGUS⁹⁰ measures the room temperature by internal sensor, and based on the set temperature, it sends a command for heating / cooling.
- Option of setting a daily/weekly automatic control program.
- The temperature controller can be used in one of two ways:
 - For controlling an additional heat source (heater, oil radiator, radiant panel) with multi-function switching units RFSA-6x, RFUS-61 or RFSC-61.
 - For control of floor heating, when the internal sensor scans the room temperature, and based on the value, controls the heating unit RFSTI-11B, which monitors the critical floor value by external sensor.
- Manual control by buttons on the unit.
- Range of measured temperature 0-55 °C.
- The backlit LCD display displays the current and set temperature, status (ON/OFF), battery status, day of the week, current time, etc.
- Battery power (1.5 V / 2x AAA - included in supply) with battery life of around 1 year based on frequency of use.
- The flat rear side of the device enables its placement anywhere in the room where you wish to measure temperature.
- Range up to 100 m (in open space), if the signal is insufficient between the controller and unit, use the signal repeater RFRP-20.
- Communication frequency with bidirectional protocol iNELS RF Control.
- Color combination of temperature unit in design of frames LOGUS⁹⁰ (plastic, glass, wood, metal, stone).

Device description

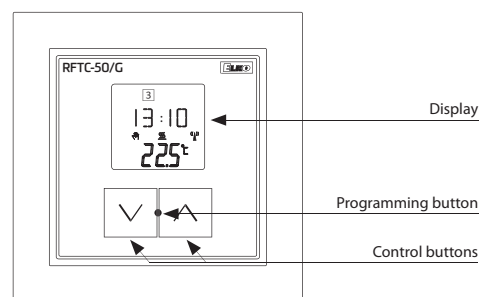

Display description

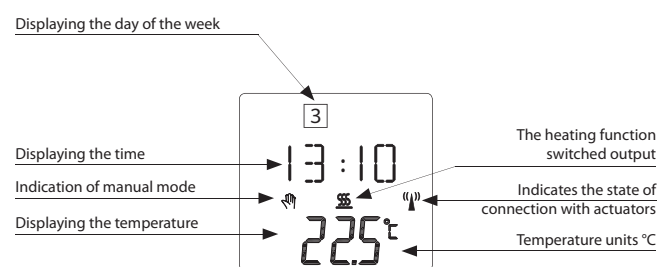

Technical parameters	RFTC-50/G
Supply voltage:	2x 1.5 V AAA battery
Battery life:	up to 1 year according to the number of controlling actuators
Temperature offset:	2 buttons V / ^
Offset:	± 5 °C
Display:	LCD, characters / see Display description
Backlighting:	YES / active – blue
Transmission indication / function:	symbols
Temperature measurement input:	1x internal sensor
Temp. measurement range and accuracy:	0 to +55 °C; 0.3 °C of the range
Transmitter frequency:	866 MHz, 868 MHz, 916 MHz
Signal transmission method:	bidirectionally addressed message
Range in free space:	up to 100 m
Minimum control distance:	20 mm

Other data	
Max. number of control.	
RFSA-6x:	4
Program:	Weekly
Operating temperature:	0 to + 55 °C
Operating position:	on the wall
Mounting:	by gluing / screwing
Protection:	IP20
Contamination degree:	2
Dimensions frame	
- plastic:	85 x 85 x 20 mm
- metal, glass, wood, granite:	94 x 94 x 20 mm
Weight:	66 g (without batteries)
Related standards:	EN 60669, EN 300 220, EN 301 489 directive R&TTE Directive, Order. No 426/2000 Coll. (Directive 1999/EC)

Compatibility				
RF Touch	eLAN-RF	RFSA-6 x	RFSTI-11B	RFATV-1
-	-	✓	✓	-



Technical parameters	RFTC-100/G
Supply voltage:	100-230 V AC / 50 - 60 Hz
Apparent input:	3 VA / cos φ = 0.1
Dissipated power:	0.3 W
Supply voltage tolerance:	+10 %; -15 %
Temperature offset:	2 buttons V / ^
Offset:	± 5 °C
Display:	LCD, characters / see Display description
Backlighting:	YES / active – blue
Transmission indication / function:	symbols
Temperature measurement input:	1x internal sensor
Temp. measurement range and accuracy:	0 to +55 °C; 0.3 °C of the range
Transmitter frequency:	866 MHz, 868 MHz, 916 MHz
Signal transmission method:	bidirectionally addressed message
Range in free space:	up to 100 m
Minimum control distance:	20 mm

Other data	
Max. number of control.	
RFSA-6x:	4
Program:	Weekly
Operating temperature:	0 to + 55 °C
Operating position:	vertical
Mounting:	in an installation box
Protection:	IP20
Contamination degree:	2
Cross-section of connecting cables (mm ²):	max. 1x 2.5, max. 2x 1.5 / with a hollow max. 1x 2.5
Dimensions frame	
- plastic:	85 x 85 x 46 mm
- metal, glass, wood, granite:	94 x 94 x 46 mm
Weight:	172 g
Related standards:	EN 60669, EN 300 220, EN 301 489 directive R&TTE Directive, Order. No 426/2000 Coll. (Directive 1999/EC)

*Comes with plastic frame. No installation into multi-frames.

Compatibility				
RF Touch	eLAN-RF	RFSA-6 x	RFSTI-11B	RFATV-1
-	-	✓	✓	✓

- The wireless controller in design LOGUS⁹⁰ measures the room temperature by internal sensor, and based on the set temperature, it sends a command for heating / cooling.
- Option of setting a daily/weekly automatic control program.
- The temperature controller can be used in one of two ways:
 - For controlling an additional heat source (heater, oil radiator, radiant panel) with multi-function switching units RFSA-6x, RFUS-61 or RFSC-61.
 - For control of floor heating, when the internal sensor scans the room temperature, and based on the value, controls the heating unit RFSTI-11B, which monitors the critical floor value by external sensor.
- Manual control by buttons on the unit.
- Range of measured temperature 0-55 °C.
- The backlit LCD display displays the current and set temperature, status (ON/OFF), battery status, day of the week, current time, etc.
- The unit power supply is 100-230 V AC.
- Range up to 100 m (in open space), if the signal is insufficient between the controller and unit, use the signal repeater RFRP-20.
- Communication frequency with bidirectional protocol iNELS RF Control.
- Color combination of temperature unit in design of frames LOGUS⁹⁰ (plastic, glass, wood, metal, stone).

Device description

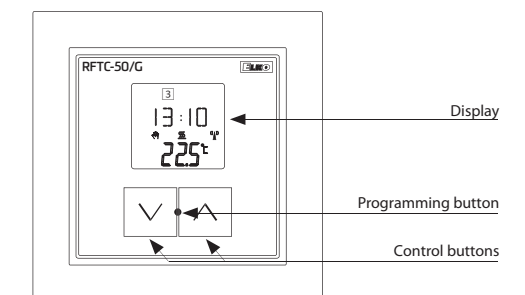

Display description

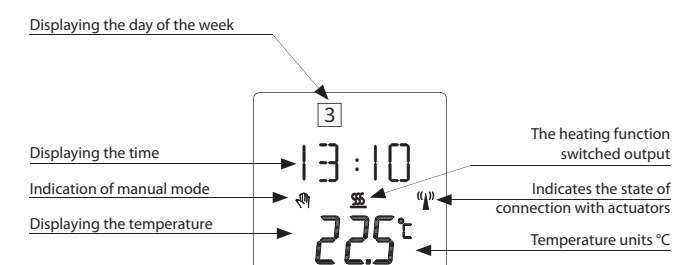

Connection

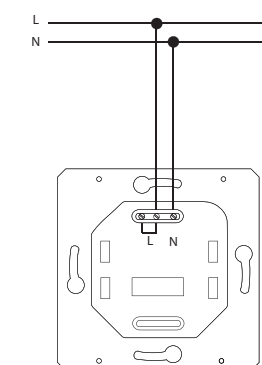



- Monitors areas (e.g. bathrooms, basements, shafts or tanks) to provide flood warning.
- Upon detecting water, the flood detector immediately sends a signal to the switched unit, which further switches on a pump, GSM gate (link to RFGSM-220M) or closes a pipe valve. (Link to valve in accessories).
- Option of connecting an external probe FP-1 (not included in supply - max. wire length 30 m).
- The programming button on the detector is used to:
 - a) setting the function with switching unit
 - b) ascertaining battery status
 - c) ascertaining signal quality between the unit and detector.
- Battery power supply (1.5 V / CR2477 - included in the supply) with battery life of around 1 year based on frequency of use.
- The detector can be placed anywhere thanks to battery power.
- Range up to 160 m (in open space); if the signal is insufficient between the controller and unit, use the signal repeater RFRP-20.
- Communication frequency with bidirectional protocol iNELS RF Control.

Device description

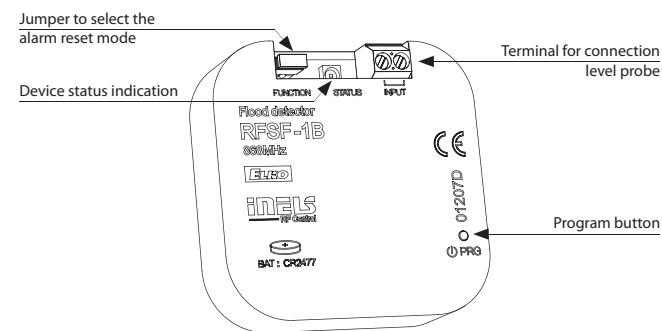

Flood probe FP-1

For more information see p. 61.

Location of the detector and probe

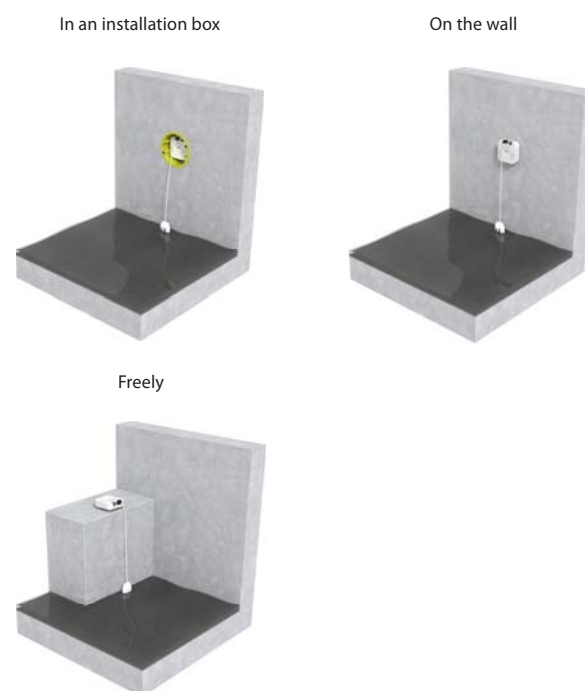

Technical parameters	RFSF-1B
Supply voltage:	1 x 3 V battery CR 2477
Battery life:	1 year
Indications / transfer function:	red LED
Reset after flooding:	JUMPER - Manual / Automatic
Programming:	with Prog button / based batteries
Measuring input:	terminal 0.5-1mm ²
Voltage measuring input:	3 V
Resistance measuring input for detecting flooding:	≤20 kΩ
Resistance measuring input for flushing detection:	≥40kΩ
Probe cable length:	max. 30 m
Frequency:	866 MHz, 868 MHz, 916 MHz
Signal transmission method:	two-way addressed message
Range in free space:	up to 160 m
Other data	
Working temperature:	-10 to +50 °C
Operating position:	any
Mounting:	glue / freely
Protection:	IP30
Degree of pollution:	2
Dimensions:	49 x 49 x 13 mm
Weight:	45 g
Standards:	EN 60730-1, EN 300 220, EN 301 489 directive R&TTE Directive, Order. No 426/2000 Coll. (Directive 1999/EC)



Technical parameters	RFTM-1
Power supply:	2x 1.5 battery AAA
Battery Life:	Appr. 2 years, (depending on the type of sensor, frequency of transmissions and pulses)
Indication	
Setting mode:	Green LED flashes - active Red LED - flashes during impulse sensor registration
Communications Test - RF STATUS:	Green LED - communication OK red LED - communication ERR
Normal operation:	no indication
Control	
Manual control:	button SET
Sensor Selection:	rotary potentiometer
Supported sensors (not included in the package):	LS (LED sensor) MS, WS (magnetic sensor) IRS (IR sensor) S0 (Contact, open collector, reed magnetic contacts)
Output	
Sending RF communication packet:	866 MHz, 868 MHz, 916 MHz
Protocol:	iNELS RF Control
Range in free space:	up to 100 m
Other data	
Working temperature:	-20 .. +50 °C *
Storage temperature:	-30 .. +70°C
Operating position:	any
Protection:	IP65
Cross-section of connecting wires:	max. 0.5 - 1 mm ²
Dimension:	72 x 62 x 34 mm
Weight:	104 g

* Pay attention to the operating temperature of batteries.

- The wireless pulse converter detects home energy meters (electric, water, gas) by means of sensors, and sends them to the wireless unit RFPM-2M.
- The energy gateway RFPM-2M acts as an interface between the meter and a smartphone.
- Measured values are displayed in the application iHC-MAIRF/MIIRF, in daily, weekly or monthly overview in graphs.
- The sensor is designed for use on existing meters and even without the impulse output "S0" (The gauge must support scan).
- RFTM-1 transfers consumption from meters using sensors - LS (LED sensor), WS (Magnetic sensor for meter), MS (Magnetic sensor), IRS (IR sensor) or by impulse output („S0“).
- For each consumption meter, it is necessary to have one pulse converter RFTM-1.
- The increased IP 65 protection is appropriate for mounting in risers, switchboards and other demanding environments.
- Battery power (1.5 V / 2x AAA - included in package) with average battery life of around 2 years (according to the type of scan, frequency of transmissions and pulses).
- Range up to 100 m (in open space), if the signal between the controller and the user is weak, use the signal repeater RFRP-20.
- Communication frequency with bidirectional protocol iNELS RF Control.

Device description

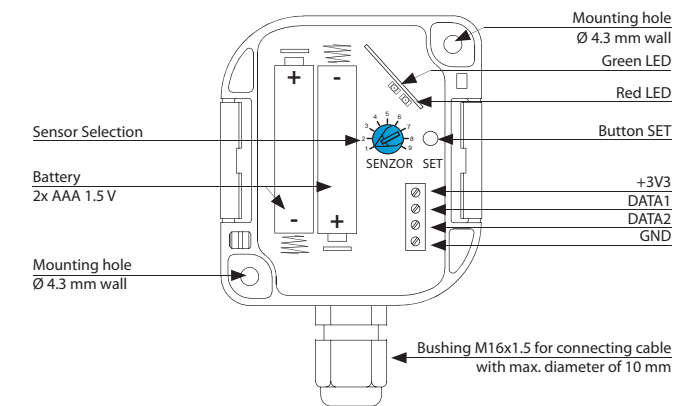

Sensors

For more information see p. 63.



- The energy gateway is a central device for assessing energy consumption (electricity, water, gas).
- It acts as an interface between the pulse converter RFTM-1 and your smartphone.
- Connection to the data network is made by means of LAN Ethernet connector or wirelessly via a Wi-Fi network.
- Monitored data is stored on internal memory storage.
- By means of the application iHC and cloud connection, it is possible to maintain online access to data and monitoring history.
- Up to 4 tariff meter readings of electricity consumption, which can be displayed in the form of kWh or financial costs.
- Option of setting reaction to specific consumption to switch the output on or off (RFS-6x and CU3).
- The unit enables connecting up to three current transformers CT50 to each other for measuring electricity.
- Direct connection to iNELS BUS using integrated CIB terminals.
- 3-module design, mounted on a DIN rail into the switchboard.
- The supply includes an internal antenna AN-I, if the unit is installed in a metal switchboard, you can use the external antenna AN-E to enhance the signal.
- The device supply voltage is provided from monitored phases.
- Range up to 100 m (in open space), if the signal between the controller and the user is weak, use the signal repeater RFRP-20.
- Communication frequency with bidirectional protocol iNELS RF Control.

Connection

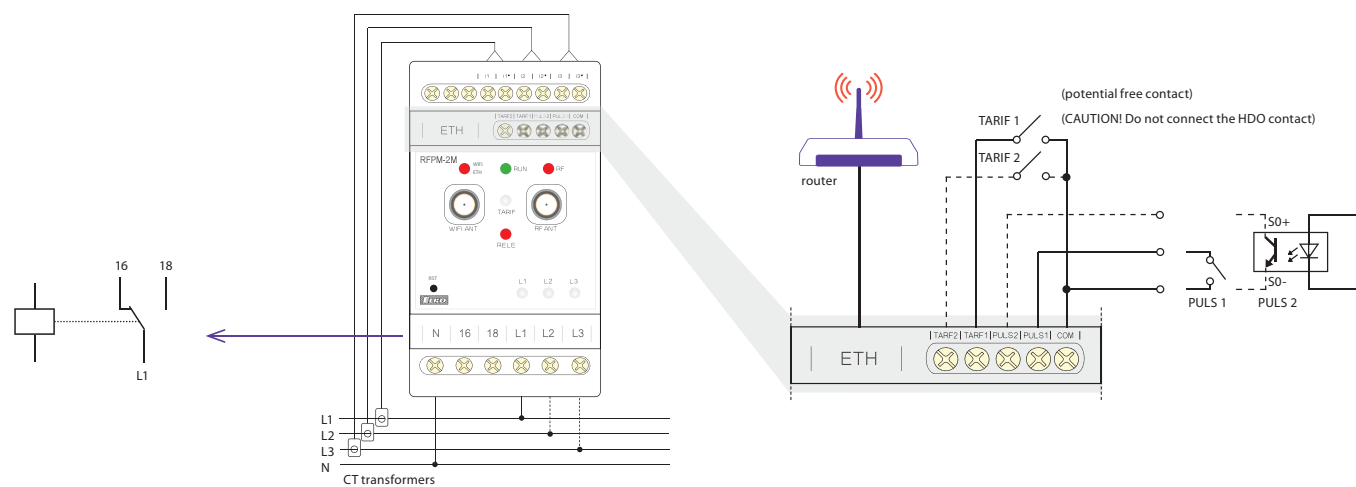

Device description

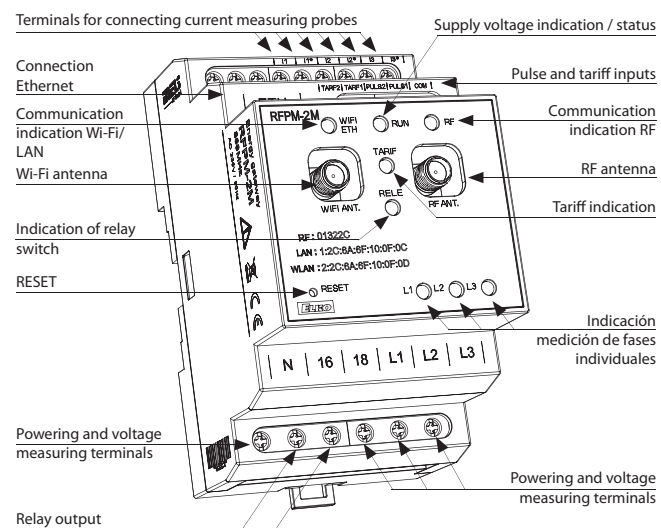

Tariff indication - RGB LED	
TARIF 1:	red
TARIF 2:	green
TARIF 3:	blue
TARIF 4:	yellow

Phase status indicator L1, L2, L3 - R/G LED	
failure (outage):	red
active phase:	green

Current transformer CT50

The package includes the current transformer CT50. For more information see p. 63.

Technical parameters	RFPM-2M
Supply voltage:	230 V AC / 50-60Hz
Supply voltage tolerance:	+15/-20%
Closed relay power input:	5 VA
Output RELE	
Number of contacts:	1 NO/ NC switches L1
Max. current:	16 A / AC1
Switching power:	4000 VA (AC1)
Mechanical service life:	3 x 10 ⁷
Electrical service life:	0.7 x 10 ⁵
Relay reaction:	programmable settings, see instruction manual
Interface RF Control	
Communication protocol:	RF Touch Compatible
Broadcasting frequency	866 MHz, 868 MHz, 916 MHz
Signal transfer method:	two-way addressed message
Output for antenna:	SMA - FEMALE*
Antenna RF:	1 dB (part of suply)
Range in open space:	up to 100 m
Controlling	
Controlling:	WEB / Mobile Applications
Button RST:	Unit reset (press 10)
Interface Wi-Fi	
Wi-Fi mode:	AP / Client (static IP / DHCP Client)
Standard:	IEEE 802.11 b/g/n / 2.4 GHz
Wi-Fi Security:	WEP, WPA-PSK, WPA2-PSK
Frequency range Wi-Fi:	RP - SMA - FEMALE*
Antenna Wi-Fi:	1 dB (part of suply)
Range:	up to 20 m
Interface Ethernet	
Connection:	LAN (static IP / DHCP Client)
Transfer speed:	10 / 100 Mbit / s
Connector:	RJ45
Preset IP address:	192.168.1.2
Measuring	
Pulse inputs:	PULS1 (S0), PULS2 (S0)
Tariff inputs:	TARF1, TARF2 - binary combination
Option of switching inputs:	switching by contact / opening by collector
Separation by isolation of power and control circuits:	reinforced Insulation (Cat. II surges by EN 60664-1)
Probes measuring current:	3x CT-50
Wireless consumption sensor:	RFTM-1
Measuring circuit	
Network:	1f-3f
Frequency:	50 - 60 Hz ±10 %
Accuracy:	Class 1.0
Current measuring coil:	max. 50 A (current transformer CT50)
Wire diameter:	max. 16 mm
Other data	
Working temperature:	-20 .. + 35°C
Storage temperature:	-30 .. +70°C
Operating position:	vertical
Mounting:	DIN rail EN60715
Protection:	IP20 from front panel / IP40 in cover
Overvoltage category:	II.
Degree of pollution:	2
Cross-section of connecting wires (mm ²):	max. 1x 2.5, max. 2x 1.5 / with a hollowmax. 1.5
Dimension:	90 x 52 x 65 mm
Weight:	125 g

* Max Tightening Torque for antenna connector is 0.56 Nm.

Methods of sensing meters

CT (Current transformer)

Opening pliers open/close on the existing wire of the measured circuit, most frequently at the main supply at the electricity meter.

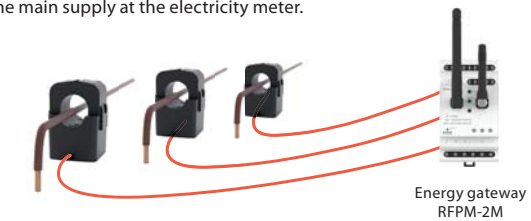

LS (LED sensor)

The LED sensor scans LED impulses on the meter, which indicates consumption by flashing.

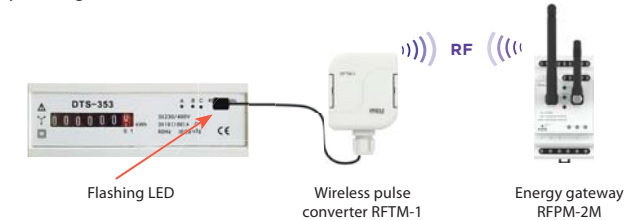

MS (Magnetic sensor)

The magnetic sensor scans movement of the numeral, upon which a permanent magnet is placed.

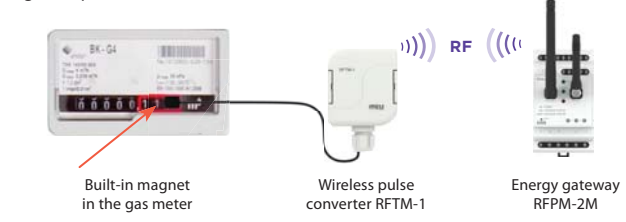

IRS (Infra Red sensor)

The IR sensor senses the reflective curtain placed on the moving number of the meter or senses the rotating indicator (mainly on water meters).

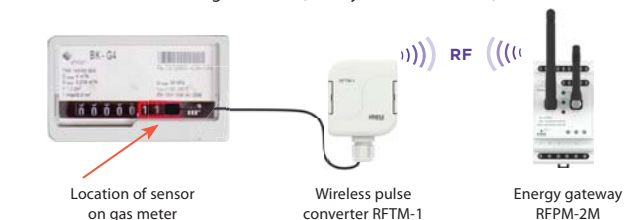

WS (Magnetic sensor for water meter)

The magnetic sensor detects the pulse that is created with each rotation of the magnetic placed on the unit dial (supported producer Maddalena - type TCM 142/08-4627).

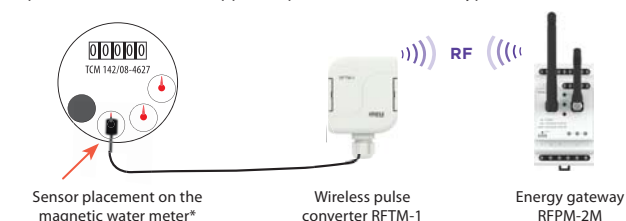

IMP (Output „S0“)

Meters with impulse output indicated as „S0“ connected by wires to terminals GND and DATA1 on the sensor RFTM-1.

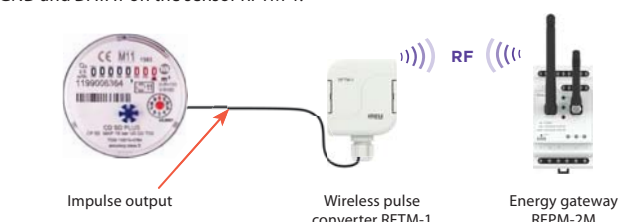



- The smoke detector is used for timely warning against a fire started in residential and commercial buildings.
- The detector uses a scanning method by means of an optical chamber having a more sensitive reaction to detection of smoke.
- Use:
 - autonomous fire detector with internal siren
 - in combination with a switching unit for external signaling (light, appliance, siren)
 - by means of the Smart RF box, detection can be displayed on your smart phone, in the form of a notification; alarms are stored in the history, which is visualized in the application iHC.
- The autotest function notifies of a fault with the detector, thereby eliminating its lack of function in case of fire.
- Anti-tamper function: an alarm is triggered if there is an unauthorized interference to detector.
- Power supply: battery 2 x 1.5 V AA, the battery life is around 1 year, ... thanks to the ability to turn off the LED indicator it is possible to extend up to 3 years.
- The detectors are compatible with switching components marked with the iNELS RF Control² RFIO² communication protocol and the eLAN-RF system components.
- Communication frequency with bidirectional protocol iNELS RF Control² (RFIO²).
- "Low Battery" Alerts by double LED flashing or on iHC App.

Technical parameters	RFSD-100	RFSD-101
Power supply:	battery 2x 1.5V AA	
Drained battery indicator:	yes	
Transmission frequency:	866 MHz, 868 MHz, 916 MHz	
Detection area:	max. 40m ²	
Optical indication:	red LED	
Assembly height:	max. 7m	
Storage temperature:	-10 .. +50°C	
Protection:	IP20	
Color:	white	
Dimension:	Ø 120 x 36 mm	

RFWD-100 | Window / Door detector



- The window / door detector is used to detect opening where activation occurs when the magnet and the sensor become separated.
- Use:
 - in combination with the switching unit for automatic light control (cellar, garage, etc.), or switching on a GSM gate
 - by means of the Smart RF box, detection can be displayed on your smart phone in the form of a notification; alarms are stored in the history, which is visualized in the application iHC.
- Anti-tamper function: an alarm is triggered if there is an unauthorized interference to detector.
- Power supply: battery 3 V / CR2032, the battery life is around 1 year, ... thanks to the ability to turn off the LED indicator it is possible to extend up to 3 years.
- The detectors are compatible with switching components marked with the iNELS RF Control² RFIO² communication protocol and the eLAN-RF system components.
- Communication frequency with bidirectional protocol iNELS RF Control² (RFIO²).
- "Low Battery" Alerts on Your iHC App.

Technical parameters	RFWD-100
Power supply:	battery 1x 3 V CR2032
Drained battery indicator:	yes
Transmission frequency:	866 MHz, 868 MHz, 916 MHz
Working temperature:	-10.. +50°C
Protection:	IP20
Color:	white
Dimension:	25 x 75 x 16 mm / 15 x 75 x 14 mm



Technical parameters	RFMD-100
Power supply:	batterie 2x 1.5 V AA
Drained battery indicator:	yes
Transmission frequency:	866 MHz, 868 MHz, 916 MHz
Detection angle:	105°
Detection distance:	max. 12 m
Recommended working height:	max. 2.2 m
Working temperature:	-10.. +50°C
Protection:	IP20
Color:	white
Dimension:	46 x 105 x 43 mm

- The motion detector PIR is used to detect persons moving inside the building interior.
- Use:
 - in combination with a switching unit for automatic control of lighting or triggering an alarm.
 - by means of the Smart RF box, detection can be displayed on your smart phone in the form of a notification; alarms are stored in the history, which is visualized in the application iHC.
- Sensitivity settings of the PIR detector for eliminating unwanted triggering.
- Integrated lighting sensor, thanks to which you can set the detector's reaction time.
- Option of activation / deactivation of the LED indicator on the detector cover.
- Anti-tamper function: an alarm is triggered if there is an unauthorized interference to detector.
- Power supply: battery 2x 1.5 V AA, the battery life is around 1 year, ... thanks to the ability to turn off the LED indicator it is possible to extend up to 3 years.
- The detectors are compatible with switching components marked with the iNELS RF Control² RFIO² communication protocol and the eLAN-RF system components.
- Communication frequency with bidirectional protocol iNELS RF Control² (RFIO²).
- "Low Battery" Alerts by double LED flashing or on iHC App.

Detection field

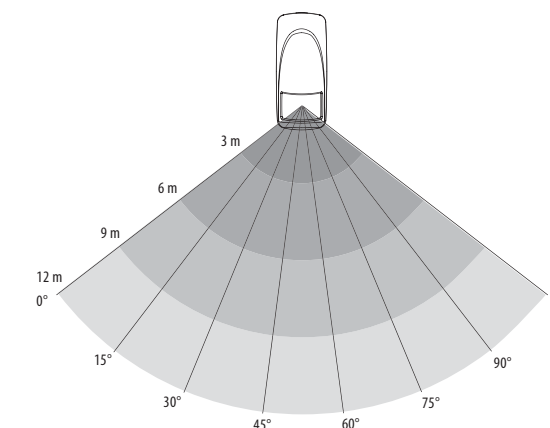

iNELS Cam | IP camera



- The cloud video camera DCS-933L, capable of scanning both day and night, is a universal monitoring solution for your home or office.
- As opposed to a standard web camera, D-Link is an independent system, which can transmit high quality images without the need for a computer connection.
- It is equipped with a motion detector, and features the function of a Wi-Fi extender/repeater, enabling improvement in range and coverage of your existing home or office wireless network.

Supported video cameras: Axis, D-link

Technical parameters	iNELS Cam
Power supply:	5 V DC adapter
Resolution:	640 x 480 px
Night light:	yes
Max. cameras in app:	up to 10





Technical parameters	RFSAI-161B/230V	RFSAI-161B/120V	RFSAI-161B/24V
Supply voltage:	230 V AC / 50-60 Hz	120 V AC / 60 Hz	12-24 V AC/DC 50-60 Hz
Apparent power:	9 VA / cos φ = 0.1	9 VA / cos φ = 0.1	-
Dissipated power:	0.7 W		
Supply voltage tolerance:	+10 %; -15 %		
Output			
Number of contacts:	1x switching (AgSnO ₂)		
Rated current:	12 A / AC1		
Switching power:	4000 VA / AC1, 384 W / DC		
Peak current:	30 A, max. 4 s at 10%		
Switching voltage:	250 V μ AC1 / 24 V DC		
Min. switching power DC:	100 mA / 10 V		
Insulation voltage between outputs and internal circuits:	reinforced insulation (Cat. III surges by EN 60664-1)		
Isolation voltage open contact:	1 kV		
Mechanical service life:	3x10 ⁷		
Electrical service life (AC1):	5x10 ⁴		
Indication of relay switch:	red LED		
Controlling			
RF command from the detector:	866 MHz, 868 MHz, 916 MHz		
Manual control:	button PROG (ON/OFF)		
External button:	max. 12 m cable*		
Range in open space:	up to 160 m		

Other data	
Open contact voltage external switch:	3 V
Resistor for the management of external switch:	<1 kΩ
Resist. of connection for open contact:	>10 kΩ
Galvanic isolation of input:	no
Operating temperature:	-15 ... + 50 °C
Storage temperature:	-30 ... + 70 °C
Working position:	any
Mounting:	free at lead-in wires
Protection:	IP30
Overvoltage category:	III.
Contamination degree:	2
Terminals:	0.5 - 1 mm ²
Terminals (CY wire, Cross-section):	2x 0.75 mm ² , 2x 2.5 mm ²
Terminal length:	90 mm
Dimensions:	49 x 49 x 21 mm
Weight:	50 g

* Control button input is at the supply voltage potential.

- Switch component with one output channel which is used in combination with detectors for automatic lighting control.
- Thanks to its unique functionality it is especially suited for hotels.
- Control wireless switch (RFWB-20 or RFWB-40), whose cover can be printed with icons according to your wishes.
- Other possible components in the installation can include a touch unit, RF Touch or smart phone (eLAN-RF, ...).
- MASTER option settings, using this feature to control other components of the installation (prog. Tool RFAF / USB).
- The terminals on the component give you the opportunity to connect a wired detector or an existing key installation.
- Switching can be controlled by the wireless twilight switch, measuring the intensity of light in the room.
- It enables connection of the switched load up to 1x 12 A (3000 VA).
- The programming button on the unit is also used for manual control of the output.
- Range up to 160 m (in open space), if the signal is insufficient between the controller and unit, use the signal repeater RFRP-20.
- For components labelled as iNELS RF Control² (RFIO²), it is possible to set the repeater function via the RFAF / USB service device.
- Communication frequency with bidirectional protocol iNELS RF Control² (RFIO²).

Device description

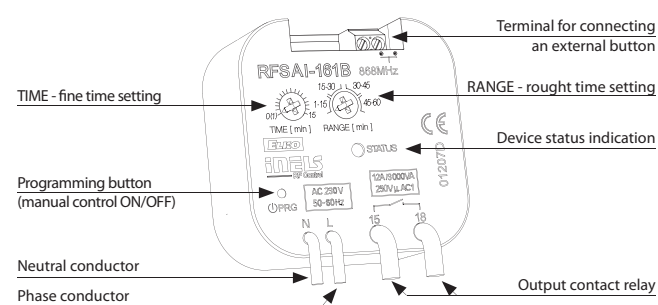

Compatible wireless detectors (Jablotron)
 Movement: JA-80P, JA-85P, JA-83P
 Door / Window: JA-81M, JA-82M, JA-83M

Connection

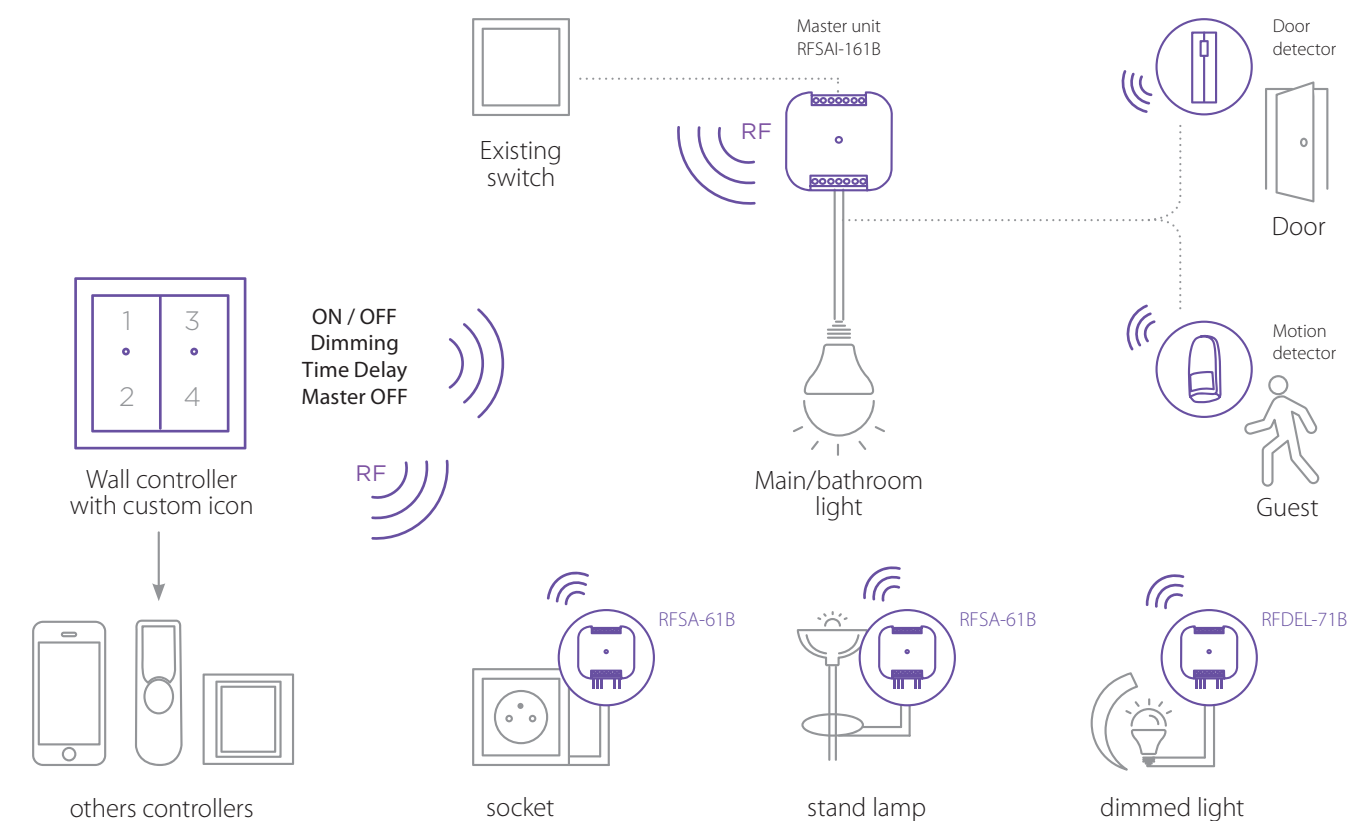

Function

When the motion detector (wireless or wired connected via terminals) captures the movement of the guest, the light ON command is sent. (It can be connected via terminals to the existing switch for permanent ON state).

The functionality of door detector is delayed OFF = after the guest (or cleaner) close the door than the timer starts running (which you can set) and the light will turn OFF. If there is movement the command from door detector (delay off) will be cancelled.

If the guest goes to sleep, press number 4 on wireless switch RFWB-40 (which is MASTER OFF button) this is the command for deactivation of the hearing detectors. At the same time the MASTER OFF is sent to all actuators which are controlled from this button.

You are able to control other units like RFDEL, RFSAI (for controlling sockets, lights, curtains) with other channels on wireless switch RFWB-40.

If the guest presses any button on the wireless switch RFWB-40 (or existing push button connected on terminal RFSAI-161B) the automatic regulation of lights will be activated.



Technical parameters	RFSTI-111B/230V	RFSTI-111B/120V	RFSTI-111B/24V
Supply voltage:	230 V AC / 50-60 Hz	120 V AC / 60 Hz	12-24 V AC / DC 50-60 Hz
Apparent input:	9 VA / $\cos \varphi = 0.1$	9 VA / $\cos \varphi = 0.1$	-
Dissipated power:	0.7 W		
Supply voltage tolerance:	+10 %; -15 %		
Temperature measurement input:	1x external TZ/TC temperature sensor input *		
Temp. measurement range and accuracy:	-20 to +50 °C; 0.5 °C of the range		
Output			
Number of contacts:	1x switching (AgSnO ²)		
Rated current:	12 A / AC1		
Switching power:	3000 VA / AC1, 384 W / DC		
Peak current:	30 A / max. 4s at 10%		
Switching voltage:	250 V μ AC1 / 24 V DC		
Min. switching power:	100 mA / 10 V		
Insulation voltage between relay outputs and internal circuits:	reinforced Insulation (Cat. III surges by EN 60664-1)		
Isolates. voltage open relay contact:	1 kV		
Mechanical service life:	3x10 ⁷		
Electrical service life (AC1):	5x10 ⁴		
Control			
Transmitter frequency:	866 MHz, 868 MHz, 916 MHz		
Range:	up to 160 m		
Other data			
Operating temperature:	-15 ... + 50 °C		
Storage temperature:	-30 ... + 70 °C		
Status indication:	red LED		
Indication regulation:	green LED		
Operating position:	any		
Mounting:	free at lead-in wires		
Protection:	IP30		
Overvoltage category:	III.		
Contamination degree:	2		
Outlets (CY wire, cross-section, length):	2 x 0.75 mm ² , 2 x 2.5 mm ² , 90 mm		
Dimensions:	49 x 49 x 21 mm		
Weight:	50 g		

* Temperature sensor input is at the supply voltage potential.

- Temperature component with one output channel serves as protection against overheating of the room, where the influence of temperature can cause damage to furniture and appliances.
- It is particularly suitable for rooms with a tropical climate.
- The component measures temperature in the range of 5...35 °C external sensor and on the basis of the set (critical) temperature fan coil switches, air conditioning.
- The BOX design lets you mount it right in an installation box, a ceiling or controlled appliance cover.
- It enables connection of the switched load up to 12 A (3000 VA).
- For components labelled as iNELS RF Control² (RFIO²), it is possible to set the repeater function via the RFAF / USB service device.
- Communication frequency with bidirectional protocol iNELS RF Control² (RFIO²).
- External sensor TC (0 ...+70 °C) or TZ (-40 ...+125 °C) for length of 3 m, 6 m, 12 m.

Device description

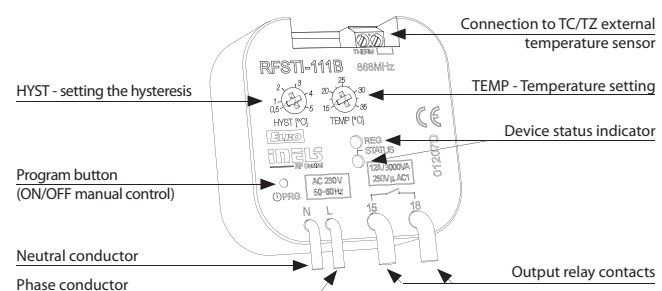

Function

The external sensor senses the temperature of the room, turns the air conditioner on and off according to the set temperature. Responds to commands from the detector - when you open the window, turn off air conditioning.

Connection

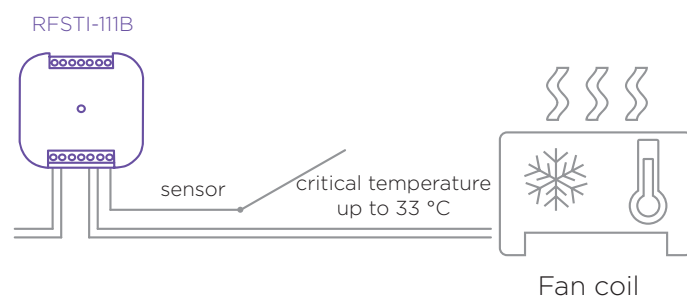

Technical parameters	RFTC-150/G
Supply voltage:	2x 1.5 V AAA battery
Battery life:	up to 1 year according to the number of controlling actuators
Temperature offset:	2 buttons ∇ / ▲
Offset:	± 5 °C
Display:	LCD, characters / see Display description
Backlighting:	YES / active - blue
Transmission indication / function:	symbols
Temperature measurement input:	1x internal sensor
Temp. measurement range and accuracy:	0 ... + 55 °C; 0.3 °C of the range
Transmitter frequency:	866 MHz, 868 MHz, 916 MHz
Signal transmission method:	bidirectionally addressed message
Range in free space:	up to 100 m
Minimum control distance:	20 mm
Other data	
Max. number of controlling actuators:	4
Program:	Weekly
Operating temperature:	0 up to + 55 °C
Operating position:	on the wall
Mounting:	by gluing / screwing
Protection:	IP20
Contamination degree:	2
Dimensions	
- plastic:	85 x 85 x 20 mm
- metal, glass, wood, granite:	94 x 94 x 20 mm
Weight:	66 g (without batteries)
Related standards:	EN 60669, EN 300 220, EN 301 489 directive R&TTE Directive, Order. No 426/2000 Coll. (Directive 1999/EC)

- The wireless controller RFCT-150/G in design LOGUS⁹⁰ measures the room temperature by internal sensor. On the basis of a set program it sends commands to the switching component RFSA-66M Switching fan coil.
- **RFCT-150/G**
 - It is possible to set automatic or manual mode.
 - Range of measured temperature 0.. 55 °C.
 - The backlit LCD display displays the current and set temperature, status (ON/OFF), battery status, day of the week, current time, etc.
 - Battery power (1.5 V / 2x AAA - included in supply) with battery life of around 1 year based on frequency of use.
 - The flat rear side of the device enables its placement anywhere in the room.
 - Color combination of temperature unit in design of frames LOGUS⁹⁰ (plastic, glass, wood, metal, stone).
- **RFSA-66M**
 - Thanks to the 6-channel design of the switching component it can control the heating / cooling mode and 3 speeds.
 - The package includes an internal antenna AN-I, in case of locating the element in a metal switchboard, you can use the external antenna AN-E for better signal reception.
 - Range up to 100 m (in open space), if the signal is insufficient between the controller and unit, use the signal repeater RFRP-20.
 - For components labelled as iNELS RF Control² (RFIO²), it is possible to set the repeater function via the RFAF / USB service device.
 - Communication frequency with bidirectional protocol iNELS RF Control² (RFIO²).

Connection

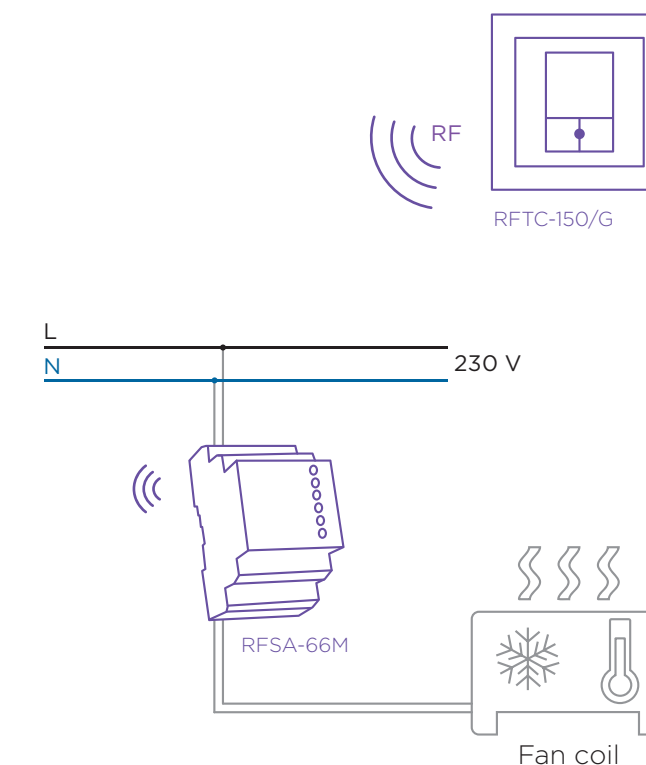

TC, TZ, Pt100 | Thermo sensors



EAN code			
TC-0:	8595188110075	TZ-0:	8595188140591
TC-3:	8595188110617	TZ-3:	8595188110600
TC-6:	8595188110082	TZ-6:	8595188110594
TC-12:	8595188110099	TZ-12:	8595188110587
Pt100-3:	8595188136136	Pt100-6:	8595188136143
Pt100-12:	8595188136150		

Technical parameters	TC	TZ	Pt100
Range:	0 °C to +70 °C	-40°C to +125°C	-30°C to +200°C
Scanning element:	NTC 12K 5 %	NTC 12K 5 %	Pt100
In air/ in water:	(τ65) 92 s / 23 s	(τ65) 62 s / 8 s	(τ0.5) - / 7 s
In air/ in water:	(τ95) 306 s / 56 s	(τ95) 216 s / 23 s	(τ0.9) - / 19 s
Cable material:	High temperature PVC	Silicone	Silicone
Terminal material:	High temperature PVC	Nickel plated copper	Copper
Protection degree:	IP67	IP67	IP67
Insulation:	-	-	double insulation silicone

Types of temperature sensors:

	TC-0	TZ-0	-
- length:	100 mm	110 mm	-
- weight:	5 g	4.5 g	-
	TC-3	TZ-3	Pt100-3
- length:	3 m	3	3 m
- weight:	108 g	106 g	68 g
	TC-6	TZ-6	Pt100-6
- length:	6 m	6 m	6 m
- weight:	213 g	216 g	149 g
	TC-12	TZ-12	Pt100-12
- length:	12 m	12 m	12 m
- weight:	466 g	418 g	249 g

τ65 (95): time, which sensor needs to heat up on 65 (95) % of ambient temperature of environment, in which is located.

- Thermister temperature sensors are made of Negative Temperature Coefficient (NTC) embedded in a PVC or metal sleeve with a thermally-conductive sealer.
- **Sensor TC**
- lead-in cable to sensor TC is made of wire CYSY 2D x 0.5 mm/ 0.02".
- **Sensor TZ**
- cable VO3SS-F 2D x 0.5 mm /0.02" with silicone insulation for use in high temperature applications.
- silicone insulation for use in high temperature applications.
- **Sensor Pt100**
- shielded silicon 2x 0.22 mm² (AWG 21), shielding connected with a case.

Resistive values of sensors in dependance on temperature

Temperature (°C)	Sensor NTC (kΩ)	Sensor Pt100 (Ω)
20	14.7	107.8
30	9.8	111.7
40	6.6	115.5
50	4.6	119.4
60	3.2	123.2
70	2.3	127.1

Tolerance of sensor NTC 12 kΩ is ± 5% by 25 °C / 77°F.
Long-term resistance stability by sensor Pt100 is 0.05% (10 000 hours).

Diagramm of sensor warm up via air

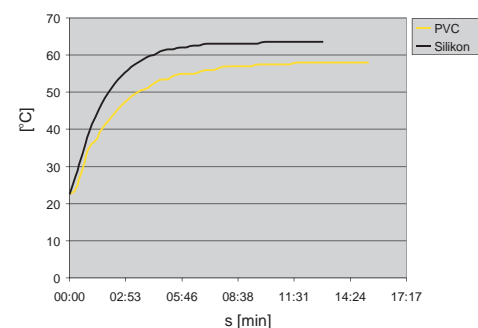

PVC -reaction to water temperature from 22.5 °C to 58°C.
Silicone - reaction to water temperature from 22.5°C to 63.5°C.

Sensor photo

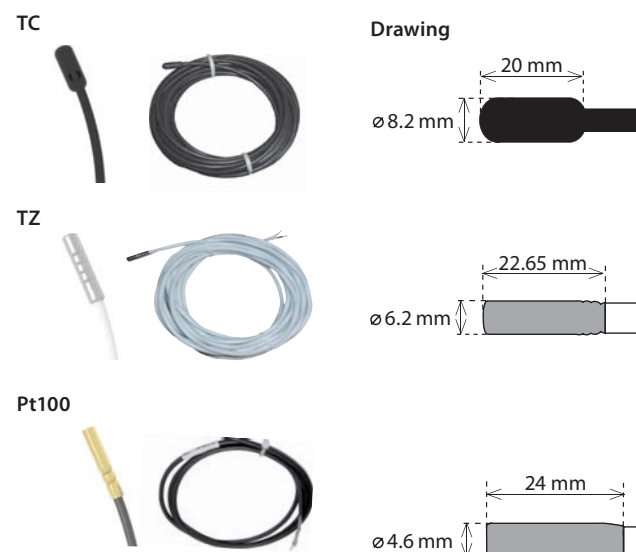

CT50 | Current transformer



- Current Transformer - CT50 has open clips, which can be opened and closed. This design allows a current transformer to be placed on the existing measuring circuit wire, usually at the main flow of the meter.

EAN code
CT50: 8595188155908

Technical parameters	CT50
Current:	50 A
Output:	0.333 V
Accuracy:	1.0
Frequency:	50 / 60 Hz
Insulation accuracy:	3 KV
Working temperature:	-15 .. 60 °C
Dimension:	31 x 46 x 32 mm

LS, MS, WS, IRS | Sensors



EAN code
LS: 8595188155762
MS: 8595188155779
WS: 8595188157940
IRS: 8595188155786

Technical parameters	LS	MS	WS	IRS
Working temperature:	-20 .. +50°C			
Cross-section of connecting wires:	max. 3.5 mm			
Wire length:	1.5 m*			
Protection:	IP20			

* the standard supplied length of 1.5m can be custom ordered in an extended version of up to 5 m.

LS (LED sensor):

- The LED sensor scans LED impulses on the meter, which indicates consumption by flashing.
- The sensor's scanner is affixed with glue above the LED diode of the meter signaling indication of consumption.
- The sensor is affixed on the terminal inside the converter RFTM-1.

MS (Magnetic sensor):

- The magnetic sensor scans movement of the numeral, upon which a permanent magnet is placed.
- The sensor's scanner is affixed with glue above the unit dial of the meter.
- The sensor is affixed on the terminal inside the converter RFTM-1.

WS (magnetic sensor water meter):

- A magnetic sensor that detects the pulse that is created by each rotation of the magnet placed on the unit dial meter.
- The sensor is mounted by sticking it above the unit dial gauges.
- The sensor is affixed on the terminal inside the converter RFTM-1.

IRS (Infra red sensor):

- The IRS sensor senses the reflective curtain placed on the moving number of the meter or senses the rotating indicator (mainly on water meters).
- The sensor's scanner is affixed with glue above the dial or the meter's rotating indicator.
- The sensor is affixed on the terminal inside the converter RFTM-1.

Single function - RFSA-11B

Function button ON/OFF

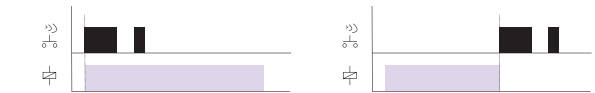

The output contact closes by pressing one button position, and opens by pressing the other button position.

Multi function - RFSA-61B, RFSA-62B, RFSA-61M, RFSA-66M, RFSAI-61B, RFSC-61, RFUS-61

Function 1 - button



The output contact will be closed by pressing the button and opened by releasing the button.

Function 2 - switch on



The output contact will be closed by pressing the button.

Function 3 - switch off



The output contact will be opened by pressing the button.

Function 4 - impulse relay



The output contact will be switched to the opposite position by each press of the button. If the contact was closed, it will be opened and vice versa.

Function 5 - delayed off

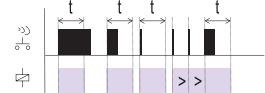

The output contact will be closed by pressing the button and opened after the set time interval has elapsed.
t = 2 s ... 60 min.

Function 6 - delayed on

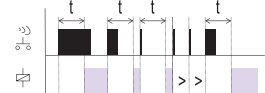

The output contact will be opened by pressing the button and closed after the set time interval has elapsed.
t = 2 s ... 60 min.

Loadability products

RFJA-12B; RFSA-62B; RFSA-66M; RFSTI-11/G; RFGSM-220M

Load type	cos φ ≥ 0.95	AC2	AC3	AC5a without compensation	AC5a with compensation	AC5b	AC6a	AC7b	AC12
Contact material AgSnO ₂ , Contact 8 A	250 V / 8 A	250 V / 5 A	250 V / 4 A	x	x	250 W	250 V / 4 A	250 V / 1 A	250 V / 1 A
Load type	AC13	AC14	AC15	DC1	DC3	DC5	DC12	DC13	DC14
Contact material AgSnO ₂ , Contact 8 A	x	250 V / 4 A	250 V / 3 A	30 V / 8 A	24 V / 3 A	30 V / 2 A	30 V / 8 A	30 V / 2 A	x

RFUS-61

Load type	cos φ ≥ 0.95	AC2	AC3	AC5a without compensation	AC5a with compensation	AC5b	AC6a	AC7b	AC12
Contact material AgSnO ₂ , Contact 14 A	250 V / 12 A	250 V / 5 A	250 V / 3 A	230 V / 3 A (690 VA)	230V / 3A (690VA) up to max input C=14uF	1000 W	x	250 V / 3 A	x
Load type	AC13	AC14	AC15	DC1	DC3	DC5	DC12	DC13	DC14
Contact material AgSnO ₂ , Contact 14 A	x	250 V / 6 A	250 V / 6 A	24 V / 10 A	24 V / 3 A	24 V / 2 A	24 V / 6 A	24 V / 2 A	x

RFSA-11B; RFSA-61B; RFSA-61M; RFSTI-11B; RFDAC-71B, RFSC-61, RFSAI-61B

Load type	cos φ ≥ 0.95	AC2	AC3	AC5a without compensation	AC5a with compensation	AC5b	AC6a	AC7b	AC12
Contact material AgSnO ₂ , Contact 16 A	250 V / 16 A	250 V / 5 A	250 V / 3 A	230 V / 3 A (690 VA)	230V / 3A (690VA) up to max input C=14uF	1000 W	x	250 V / 3 A	250 V / 10 A
Load type	AC13	AC14	AC15	DC1	DC3	DC5	DC12	DC13	DC14
Contact material AgSnO ₂ , Contact 16 A	x	250 V / 6 A	250 V / 6 A	24 V / 10 A	24 V / 3 A	24 V / 2 A	24 V / 6 A	24 V / 2 A	x

Multi function RFDA-73M/RGB, RFDEL-71B, RFDEL-71M, RFDSC-71, RFDAC-71B

Light scene function 1

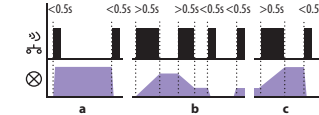

- a) By pressing the programmed button for less than 0.5 s, the light illuminates; it goes out by pressing again.
- b) By pressing the programmed button for more than 0.5 s, fluid brightness regulation will occur. After releasing the button, the brightness level is saved in the memory, and pressing the button shortly later will switch the light on/off to this intensity.
- c) It is possible to readjust the change in intensity at any time by a long press of the programmed button. The actuator remembers the adjusted value even after disconnecting from the power supply.

Light scene function 2

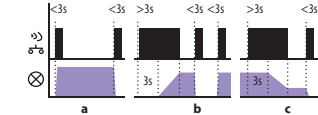

- a) By pressing the programmed button for less than 3 s, the light illuminates; it goes out by pressing again.
- b) In order to limit undesirable control of brightness, fluid brightness control occurs only by pressing a programmed button for over 3 s. After releasing the button, the brightness level is saved in the memory, and pressing the button shortly later will switch the light on/off to this intensity.
- c) It is possible to readjust the change in intensity at any time by pressing the programmed button for over 3 s. The actuator remembers the adjusted value even after disconnecting from the power supply.

Light scene function 3

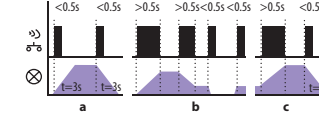

- a) By pressing the programmed button for less than 0.5 s, the light fluidly illuminates for a period of 3 s (at 100% brightness). By pressing the button shortly again, the light will continuously switch off for 3 seconds.
- b) By pressing the programmed button for more than 0.5 s, fluid brightness regulation will occur. After releasing the button, the brightness level is saved in the memory, and pressing the button shortly later will switch the light on/off to this intensity.
- c) It is possible to readjust the change in intensity at any time by a long press of the programmed button. The actuator remembers the adjusted value even after disconnecting from the power supply.

Light scene function 4

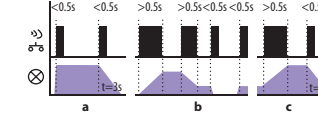

- a) By pressing the programmed button for less than 0.5 s, the light illuminates. By pressing the button shortly again, the light will continuously switch off for 3 seconds (at 100% brightness).
- b) By pressing the programmed button for more than 0.5 s, fluid brightness regulation will occur. After releasing the button, the brightness level is saved in the memory, and pressing the button shortly later will switch the light on/off to this intensity.
- c) It is possible to readjust the change in intensity at any time by a long press of the programmed button. The actuator remembers the adjusted value even after disconnecting from the power supply.

Function sunrise

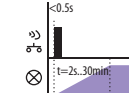

After pressing the programmed button, the light begins to illuminate in the programmed time interval in a range of 2 seconds to 30 minutes.

Function sunset

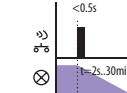

After pressing the programmed button, the light begins to dim in the programmed time interval in a range of 2 seconds to 30 minutes.

Function ON/OFF

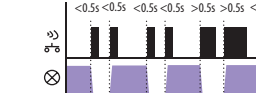

If the light is switched off, pressing the programmed button will switch it on. If the light is switched on, pressing the programmed button will switch it off.

Rating of the light source ELKO lighting on dimmers ELKO EP

	LED bulb		LED spot lights			LED panels		LED / RGB strip						
	DLB-E27-806-2K7	DLB-E27-806-5K	DLSL-GU10-350-3K	LSL-GU10-350-3K	LSL-GU10-350-5K	LP-6060-3K	LP-6060-6K	LED strip 7.2W	LED strip 14.4W	LED strip 19.2W	LED strip 28.8W	RGB strip 7.2W	RGB strip 14.4W	
RFDSC-71	✓ 21	✓ 21	✓ 45	✓ 25	✓ -	-	-	-	-	-	-	-	-	-
RFDEL-71B	✓ 11	✓ 11	✓ 25	✓ 13	✓ 13	-	-	-	-	-	-	-	-	-
RFDA-73M/RGB	-	-	-	-	-	-	-	✓ 3x8m	✓ 3x4m	✓ 3x5m	✓ 3x4m	✓ 20m	✓ 10m	-
RFDAC-71B	-	-	-	-	-	✓ 50	✓ 50	-	-	-	-	-	-	-

WARNING!

May lead to different results based on the state of network cable length and other factors.

This table contains the results of tests that were conducted internally and therefore is ONLY for customers only informative. The products were tested in test laboratories ELKO EP, and therefore the company assumes no responsibility for any imitation test environment.

Inductive and capacitive loads must not be connected simultaneously!

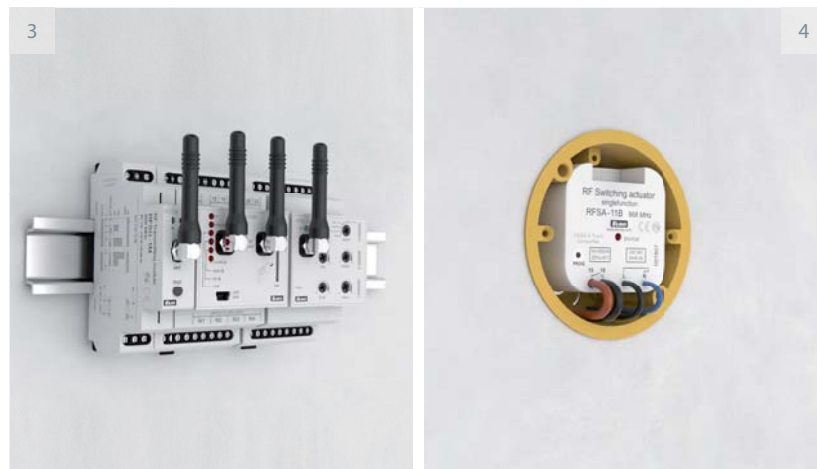
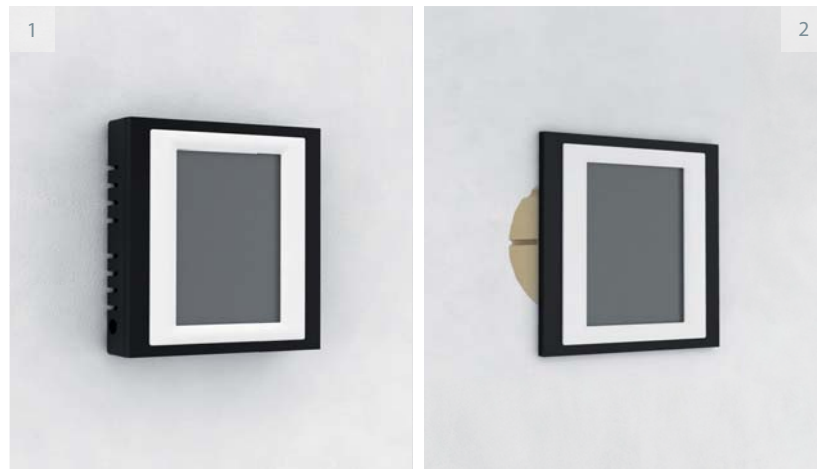

1) Surface mounted

Wall mounted or in an installation box with spacing of 65 mm.

RF Touch-W	RFTC-10/G
RFWB-20/G	RFCT-50/G
RFWB-40/G	RFCT-150/G

2) Flush mounted

RF Touch-B	RFCT-100/G
RFSTI-11/G	RFDW-71

3) DIN Rail mounted

On DIN rail according to EN 60715.

RFSG-1M	RFDEL-71M
RFGSM-220M	RFSA-61M
RFPM-2M	RFSA-66M
RFDA-73M/RGB	RFSA-166M

4) Mounted to or in the installation box

RFIM-20B	RFJA-12B
RFIM-40B	RFJA-32B
RFDAC-71B	RFSF-1B
RFDEL-71B	RFSTI-11B
RFSA-11B	RFTI-10B
RFSA-61B	RFSAI-161B
RFSA-62B	RFSTI-111B
RFSAI-61B	

5) Mounted into the cover of appliance

RFDAC-71B	RFSAI-61B
RFDEL-71B	RFJA-12B/230V
RFSA-11B	RFJA-12B/24V
RFSA-61B	RFSAI-161B
RFSA-62B	RFSTI-111B

6) Surface mounted

RFSOU-1	RFSD-100
RFUS-61	RFMD-100
RFTM-1	RFWD-100
RFSF-1B	

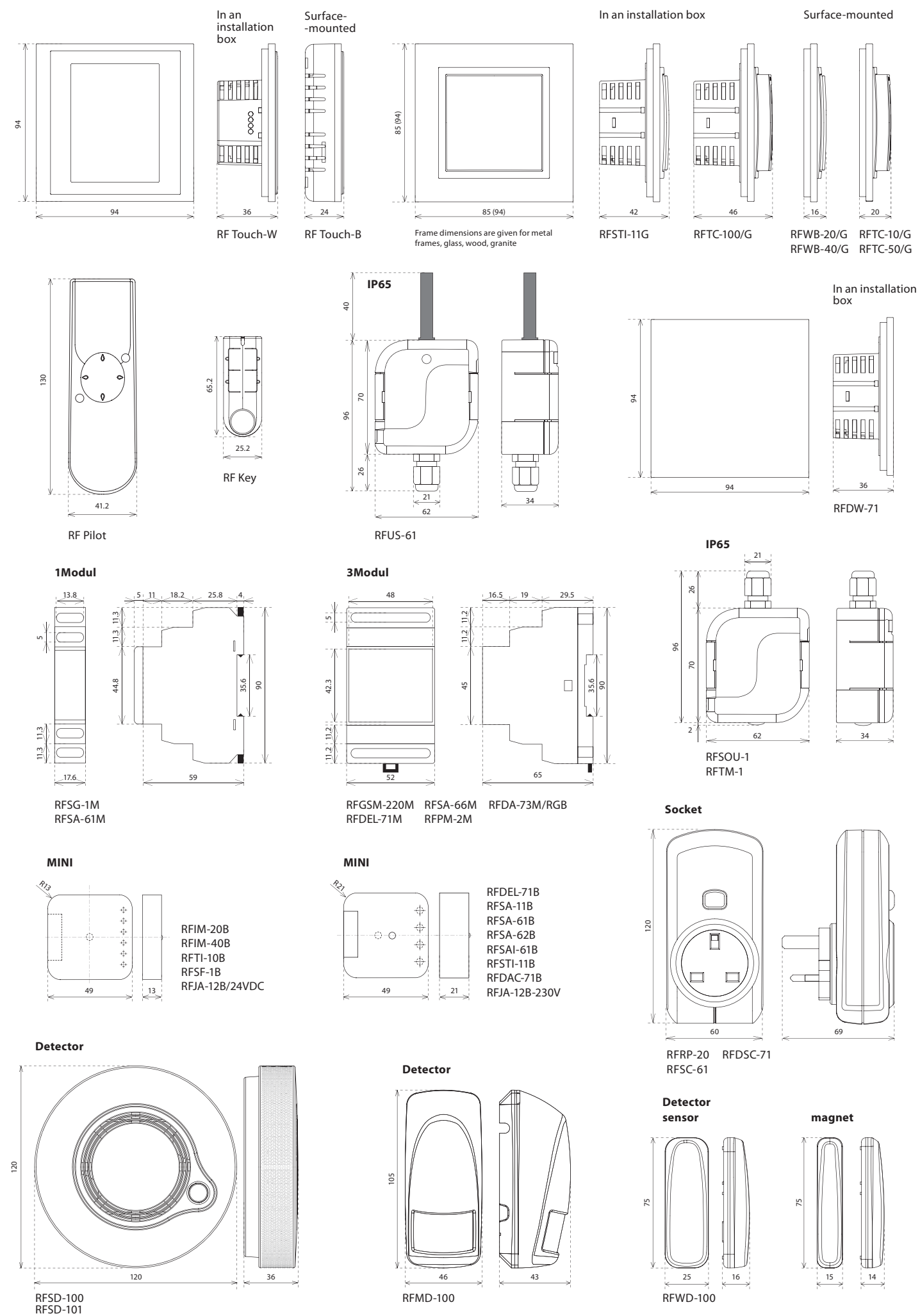

Communication between units (transmitters and receivers) takes place wirelessly on a frequency of 868 – 916 MHz based on standards in the given country on an entirely unique protocol RFIO. RFIO is a proprietary wireless protocol of ELKO EP, which is unique for its structure. In the USA, there is also available a variety of units with the protocol Z-Wave (916 MHz), which is compatible also with other producers of similar devices on the same protocol.

Available frequency for individual territories:

866 MHz	India	916 MHz	North / South America, Australia
868 MHz	EU, UA, RU, Middle east		New Zealand

Advantages of the RFIO protocol:

- Reliable transfer of small data packets with transfer speed of up to 100 kbit/s
- No fees or licenses required
- Used frequencies do not collide with Wi-Fi /Bluetooth devices and wireless units at 2.4 GHz (ZigBee)
- It does not needlessly overwhelm communications space with unaddressed commands
- Low power radio
- Routing - Data transfer between wireless units takes place by a system where other receivers within range help transfer information (packets) to the distant receiver, which itself would be out of range. It is thus possible to cover larger buildings and increase reliability of transmission for more complex buildings.

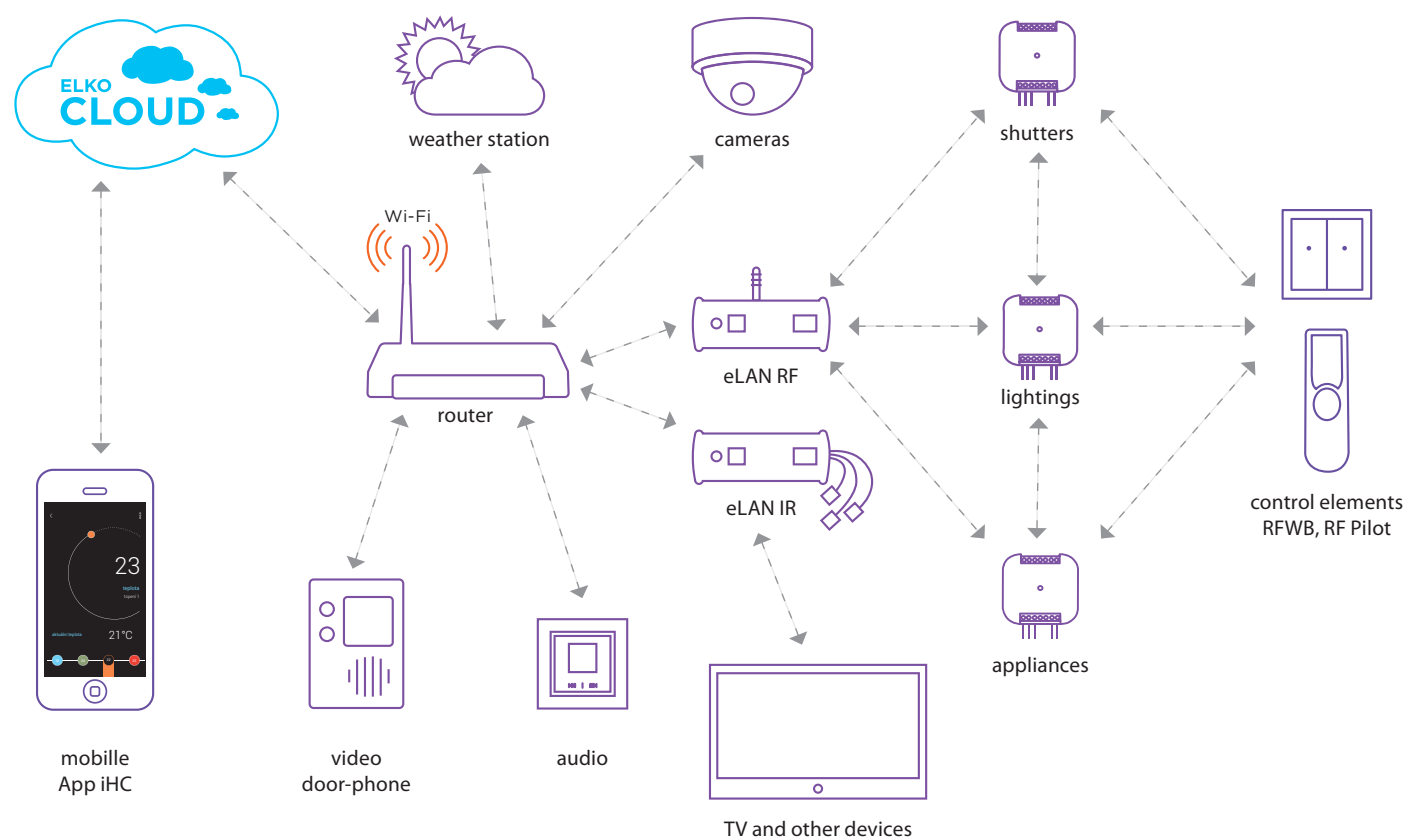

Basic sets

RFSET-SW2-Z1

- 1x Wireless switch unit RFSA-11B
- 1x Wireless wall controller RFWB-20/G - white

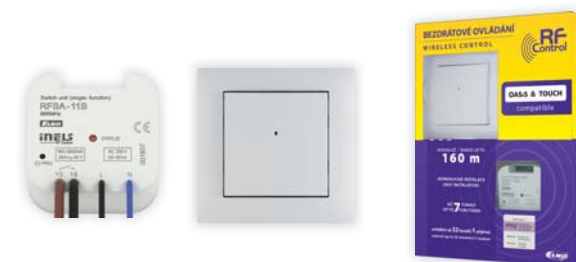

RFSET-SK-Z1

- 1x Wireless switch unit RFSA-11B
- 1x Keychan RF Key/B - black



RFSET-SIM2-Z1

- 1x Wireless switch unit RFSA-11B
- 1x Wireless contact converter RFIM-20B



Multifunction sets

RFSET-SW-F1

- 1x Wireless switch unit RFSA-61B
- 1x Wireless wall controller RFWB-40/G - white

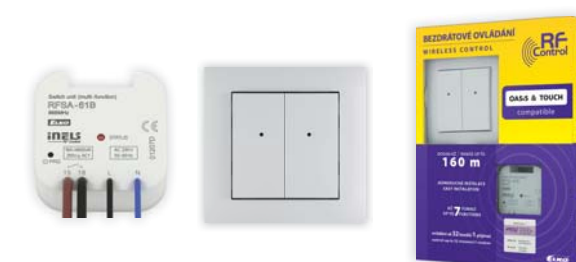

RFSET-SK-F1

- 1x Wireless switch unit RFSA-61B
- 1x Keychan RF Key/B - black



RFSET-SMK-F1

- 1x Wireless switch unit RFSA-61M with added antenna A-NI
- 1x Keychan RF Key/B - black



RFSET-RGB- RFKEY

- 1x Wireless coloured bulb RF-RGB-LED-550
- 1x Keychan RF Key/B - black



THE GAME OF LIGHTS



KIT TO CONTROL LIGHTS VIA SMARTPHONE

It's never been easier to set the appropriate ambience for reading a book or watching a movie or a party with friends. All you need is wireless bulbs and a smart box, then you can control every device from the comfort of your smartphone, tablet or smart TV. You can't just control colored or white light bulbs, but also other appliances too.

RADIO & MUSIC IN THE SWITCH



KIT FOR CONTROLLING MUSIC, WHICH PERFECTLY FITS IN YOUR HOME'S INTERIOR

LARA is a music and internet radio player. We have registered 40 favorite Czech radio stations as presets stations, however you can easily change it using the configurator. LARA plays the music, which is stored in the NASA storage or in the external source (phone, MP3 player) that is connected through a cable on the front panel of the device. Built-in amplifier that allows direct connection of speakers (in the same LOGUS⁹⁰ design) or allows connection of external in-wall or ceiling speakers.

ONE CONTROLLER FOR ALL



KIT FOR CONTROLLING IR DEVICES VIA A SMARTPHONE

Thanks to the Smart IR box, you can control the home appliances via a Smartphone. Thus you no longer need a bunch of controllers, you do not have to look for them, and you do not need to replace the battery. You always stick your phone in your pocket, always at hand. Moreover, you can control other devices which are placed in another room (e.g. you can turn off the TV in the children room).

YOUR HOUSE UNDER „THE THUMB“



CONTROL YOUR HOUSE VIA A SMARTPHONE

The kit "House under the thumb" which you're holding in your hands is the basic starter kit for you, which would like to make your home more comfortable. The starter kit consists of 2 colored wireless bulbs, 1 x switching socket and 1 x camera, which allows you to try the basic units of iNELS RF Control – wireless solution. Everything is preset to ensure fast and easy control.

Virtual kits

The virtual kit is a set of wireless units that are packed individually (as an individual product), but on the other hand, they are preset together (they are meant to work together) to ensure a simple installation. They are offered at a discounted price and it is not possible to separate any unit from this price.

UNDERFLOOR HEATING - BY WATER

Any wireless temperature regulator measures the room temperature, it compares with set temperature and time program, then sends a command to switch on the units. Based on the command from the temperature regulator, 6-channels switching unit is able to control up to 6 thermostats corresponding to heating circuits.

KIT CONSISTS OF:

Wireless temperature controller RFTC-50/G, wireless switch unit (6 outputs) RFSA-66M, thermodrivers TELVA/230V.

UNDERFLOOR HEATING - BY ELECTRICITY

Temperature and switching unit (two in one) measures the floor temperature via external sensor (built-in). Then it sends data to wireless touch unit RF Touch, which compares it with the temperature set along with the time schedule and then sends a command back to switch on/switch off the heating circuits. It is possible to connect up to 4 temperature/switching units.

Advice 1) If just one reference temperature is enough for you, so then it can be measured by temperature sensor RFTI-10B and to switch up to 6 independent heating circuits you can use 6-channels switching actuator RFSA-66M. Advice 2) The wireless unit RF Touch can be replaced by Smart RF box and all can be controlled via your smartphone. Both solution can be used together.

KIT CONSISTS OF:

Switching actuator with thermosensor RFSTI-11/G, Wireless touch unit RF Touch.

HEATING WITH SAVINGS



KIT TO CONTROL HEATING VIA WIRELESS RF TOUCH UNIT

Includes 3 wireless thermostats that are installed instead of the standard radiator valves. It measures the room temperature and sends it to the RF Touch control unit. RF Touch compares it with the temperature set along with time schedule and sends a command to open or close the valve. You can set heating programs in the weekly schedule, separately for each circuit (room).

REMOTE HEATING



KIT TO CONTROL HEATING VIA SMARTPHONE

It includes 3 wireless thermostats that are installed instead of the standard radiator valves. They measure the room temperature and send it to the Smart RF box. The Smart RF box compares it with the temperature set along with the time schedule in the application of your phone and sends a command to open or close the valve. You can always turn on the heating circuit via an app, whether you're at home, or just going to visit your cottage and do not want to come to unheated place.

EASY HEAT REGULATION



KIT FOR WIRELESS TEMPERATURE REGULATION IN THE HOME

This kit enables convenient and quick control of heater, oil heater, panel heater or portable air conditioner. Just plug the device into controlled switching sockets and appropriately place your controller RFTC-50/G. The desired temperature is set on the controller, that compares it with the current record and it sends a command to turn the device ON.

Virtual kits

TECH. SUPPORT



+420 800 100 671

AGAINST THE FLOOD

A wireless sensor monitors the water leaks or flooding in the critical places (basement, pits, shafts, bathroom, laundry room,...) and sends immediately a command to the switching unit to close the solenoid valve of the main water supply. You can be also informed of that accident through a GSM gateway by sending SMS text messages.

KIT CONSISTS OF:

Switch unit RFUS-61, wireless flood detector RFSF-1B, flood probe FP-1.

We recommend: solenoid valve: MPW SS 304 - 1/2 (3/4) 230V AC.

COLORED RGB LED STRIP

The app in your smartphone can send (through RF smart box) the commands to the dimming unit to which the RGB strip is connected. From your app it is possible to switch ON/OFF, to set the color or to run the scene of automatic color blending.

Advice 1) The colored RGB strip can be controlled through RF Pilot, by controllers RFWB-20/40, RF Key,...

Advice 2) If you do not want the colored RGB strip, we can replace it by monochromatic (warm white, cool white, red, ...). Then you can connect 8 m of monochromatic strip (power 7.2W/m) to RFDA-73M/RGB to each output.

KIT CONSISTS OF:

Smart RF box, dimmer RFDA-73M/RGB, 2 x 5m coloured RGB strip 7.2 W/m, power supply 230V/12V/100W.

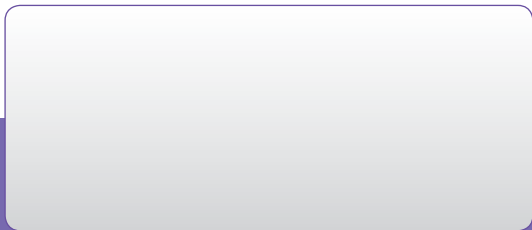
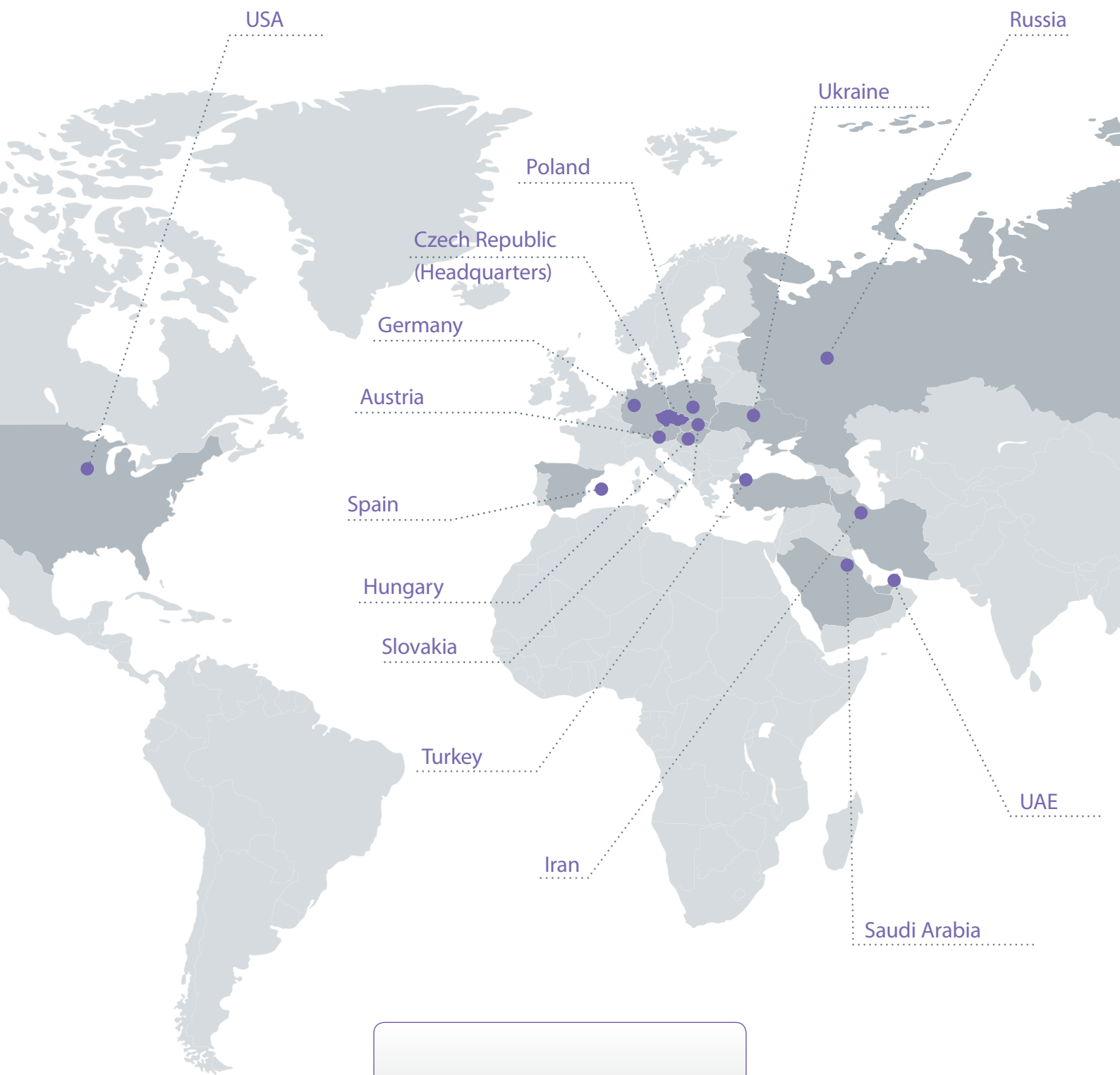

ELKO EP, s.r.o.

Palackeho 493 | 769 01 Holesov, Vsetuly | Czech Republic
phone: +420 573 514 221 | fax: +420 573 514 227 | elko@elkoep.com | www.elkoep.com

Published: 09/2017 | Modifications or amendments reserved | © Copyright ELKO EP, s.r.o. | 1st edition